

# Technical data sheet

**CE:** Ref 01023191 - UPC/EAN 737859231919  
**UK:** Ref 01023191 - UPC/EAN 737859231919  
**US:** Ref 01023192 - UPC/EAN 737859231919  
**JP:** Ref 01023193 - UPC/EAN 737859231919

**Description:**

**Belle de Nuit - Chandelier 40 lights - white**  
**Belle de Nuit - Chandelier 40 luces - blanco**

**Collection:**

**BELLE DE NUIT**

**Mounting:**

Chandelier

**Environment:**

Chandelier entirely made in porcelain. Made in different finishes to be able to match all decorative ambiances. Not very heavy to make more easy its installation. Bespoke measures under request.

**Installation and assembly:**

Follow instructions of the installation guide

**Electrical characteristics:**

**Max. Power:** 40 x 18W  
**Tension:** CE-UK: 220/240VAC US-JP: 100/125VAC  
**Frequency:** 50/60Hz  
 Dimmer not included / LED bulb non dimmable

**Recommended Bulb**

Bulb not included	<b>Bulb reference</b>
<b>CE:</b> 40 x G9 Led 3W 220V (190Lm)	01089407
<b>US:</b> 40 x G9 Led 3W 110V (190Lm)	

**Certificates:**

CE, SASO  
UL

**Physical characteristics:**

1 Box / 202,67 x 100 x 100 cm / 2,027 m3  
 1 Box / 79 3/4 x 39 1/4 x 39 1/4 inches / 122860 in3  
 Gross weight 129,6 kg. / Net weight 27,4 kg.



**LLADRÓ** BdN - Chand.

Esta luminaria es compatible con bombillas de clases energéticas:

A++  
A+  
A  
B  
C  
D  
E

874/2012 



**Sketch**

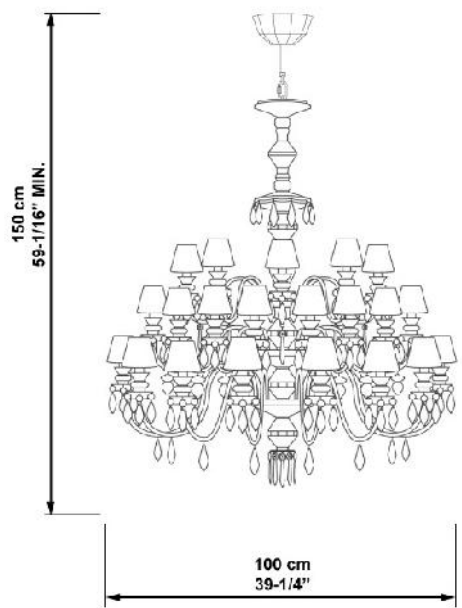

# Technical data sheet

<b>CE:</b>	Ref 01023214 - UPC/EAN 737859232145
<b>UK:</b>	Ref 01023214 - UPC/EAN 737859232145
<b>US:</b>	Ref 01023215 - UPC/EAN 737859232145
<b>JP:</b>	Ref 01023216 - UPC/EAN 737859232145

**Description:**

**Belle de Nuit - Chandelier 24 lights - black**  
**Belle de Nuit - Chandelier 24 luces - negro**

**Collection:**

**BELLE DE NUIT**

**Mounting:**

Chandelier

**Environment:**

Chandelier entirely made of porcelain. Made in different finishes to match all decorative ambiences. Not very heavy to simplify its installation. Bespoke measures available under request.

**Installation and assembly:**

Follow instructions of the installation guide

**Electrical characteristics:**

**Max. Power:** 24 X 18W  
**Tension:** CE-UK: 220/240VAC US-JP: 100/125VAC  
**Frequency:** 50/60Hz  
Dimmer not included / LED bulb non dimmable

**Recommended Bulb**

Bulb not included	Bulb reference
<b>CE:</b> 24 x G9 Led 3W 220V (190Lm)	01089407
<b>US:</b> 24 x G9 Led 3W 110V (190Lm)	

**Certificates:**

CE, SASO  
UL

**Physical characteristics:**

1 Box / 151,487 x 100 x 100 cm / 1,515 m3  
1 Box / 59 3/4 x 39 1/4 x 39 1/4 inches / 92049 in3  
Gross weight 44,1 kg. / Net weight 21,2 kg.



**Sketch**

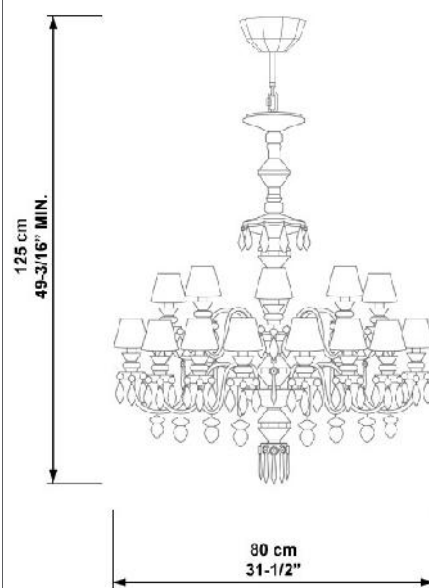

# Technical data sheet

**CE:** Ref 01023217 - UPC/EAN 737859232176  
**UK:** Ref 01023217 - UPC/EAN 737859232176  
**US:** Ref 01023218 - UPC/EAN 737859232176  
**JP:** Ref 01023219 - UPC/EAN 737859232176

**Description:**

**Belle de Nuit - Wall 2 lights - black**  
**Belle de Nuit - Aplique pared 2 luces - negro**

**Collection:**

**BELLE DE NUIT**

**Mounting:**

Wall light

**Environment:**

Wall lamp made of porcelain with decorative back mirror to enhance light effect. Made in different finishes to match all decorative ambiances. Easy to fit for a fast installation. Bespoke measures available under request.

**Installation and assembly:**

Follow instructions of the installation guide

**Electrical characteristics:**

**Max. Power:** 2 X 18W  
**Tension:** CE-UK: 220/240VAC US-JP: 100/125VAC  
**Frequency:** 50/60Hz  
 Dimmer not included / LED bulb non dimmable

**Recommended Bulb**

Bulb not included	<b>Bulb reference</b>
<b>CE:</b> 2 x G9 Led 3W 220V (190Lm)	01089407
<b>US:</b> 2 x G9 Led 3W 110V (190Lm)	

**Certificates:**

CE, SASO

**Physical characteristics:**

1 Box / 4,856 x 100 x 100 cm / 0,049 m3  
 1 Box / 2 x 39 1/4 x 39 1/4 inches / 3081 in3  
 Gross weight 3,1 kg. / Net weight 1,8 kg.



**Sketch**

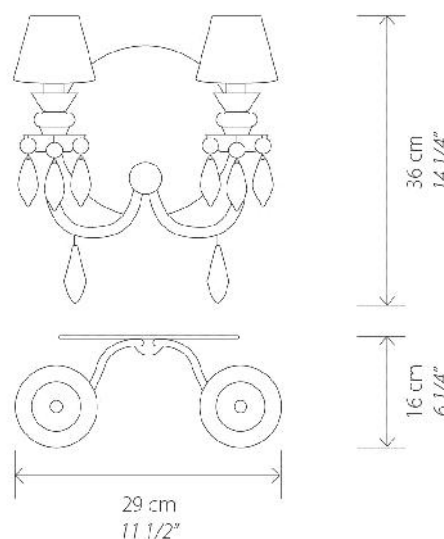

# Technical data sheet

**CE:** Ref 01023220 - UPC/EAN 737859232206  
**UK:** Ref 01023221 - UPC/EAN 737859232206  
**US:** Ref 01023222 - UPC/EAN 737859232206  
**JP:** Ref 01023223 - UPC/EAN 737859232206

**Description:**

**Belle de Nuit - Table Lamp - black**  
**Belle de Nuit - Lámpara de sobremesa - negro**

**Collection:**

**BELLE DE NUIT**

**Mounting:**

Table lamp

**Environment:**

Table lamp body in porcelain. Available in different finishes to match all decorative ambiances

**Installation and assembly:**

Follow instructions of the installation guide

**Electrical characteristics:**

**Max. Power:** 1 x 18W  
**Tension:** CE-UK: 220/240VAC US-JP: 100/125VAC  
**Frequency:** 50/60Hz  
 Dimmer not included

**Recommended Bulb**

Bulb not included	<b>Bulb reference</b>
<b>CE:</b> 1 x E27 LED 6W (600 Lm)	01089432
<b>US:</b> 1 x E26 LED 6W (600 Lm)	

**Certificates:**

CE, SASO  
UL

**Physical characteristics:**

1 Box / 49,7 x 32,3 x 56,8 cm / 0,091 m3  
 1 Box / 19 1/2 x 12 3/4 x 22 1/4 inches / 5532 in3  
 Gross weight 3,3 kg. / Net weight 1,3 kg.

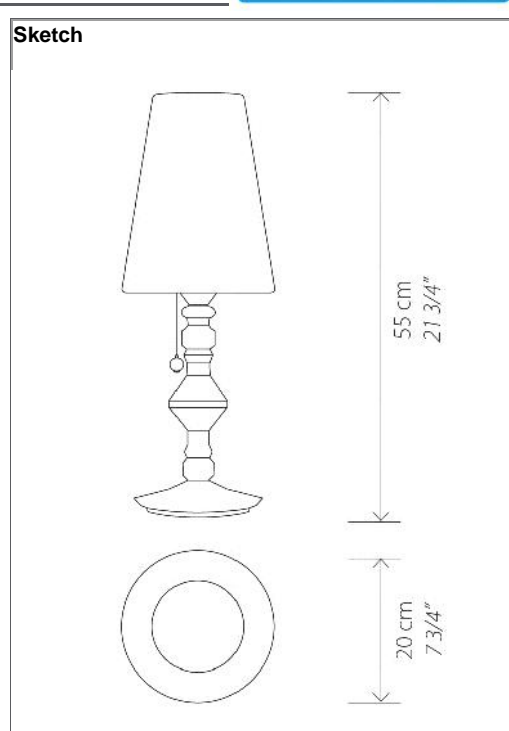
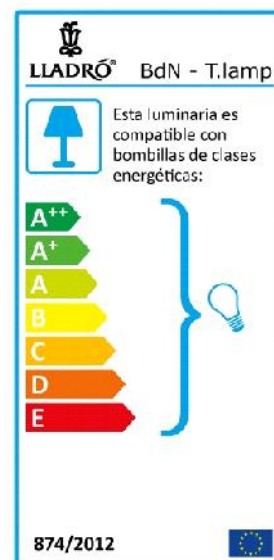

# Technical data sheet

**CE:** Ref 01023224 - UPC/EAN 737859232244  
**UK:** Ref 01023225 - UPC/EAN 737859232244  
**US:** Ref 01023226 - UPC/EAN 737859232244  
**JP:** Ref 01023227 - UPC/EAN 737859232244

**Description:**

**Belle de Nuit - Lithophane Table Lamp - black**  
**Belle de Nuit - Lámpara de sobremesa con Litofanía - negro**

**Collection:**

*BELLE DE NUIT*

**Mounting:**

Table lamp

**Environment:**

Both lamp body and lampshade are made of porcelain. Available in different finishes to match all decorative ambiances.

**Installation and assembly:**

Follow instructions of the installation guide

**Electrical characteristics:**

**Max. Power:** 1 x 18W  
**Tension:** CE-UK: 220/240VAC US-JP: 100/125VAC  
**Frequency:** 50/60Hz  
 Dimmer not included / LED bulb non dimmable

**Recommended Bulb**

	<b>Bulb reference</b>
<b>Bulb not included</b>	
<b>CE:</b> 1 x G9 Led 3W 220V (190Lm)	01089407
<b>US:</b> 1 x E12 Dimmable candle Led 4W	

**Certificates:**

CE, SASO  
UL

**Physical characteristics:**

1 Box / 17,9 x 24,9 x 42,3 cm / 0,019 m3  
 1 Box / 7 x 9 3/4 x 16 3/4 inches / 1143 in3  
 Gross weight 1,4 kg. / Net weight 0,7 kg.



**Sketch**

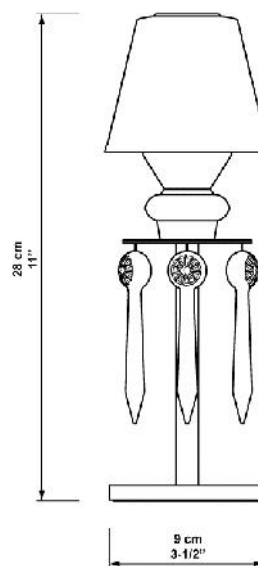

# Technical data sheet

<b>CE:</b>	Ref 01023228 - UPC/EAN 737859232282
<b>UK:</b>	Ref 01023228 - UPC/EAN 737859232282
<b>US:</b>	Ref 01023229 - UPC/EAN 737859232282
<b>JP:</b>	Ref 01023230 - UPC/EAN 737859232282

**Description:**

**Belle de Nuit - Chandelier 12 lights - green**  
**Belle de Nuit - Chandelier 12 luces - verde**

**Collection:**

**BELLE DE NUIT**

**Mounting:**

Chandelier

**Environment:**

Chandelier entirely made of porcelain. Made in different finishes to match all decorative ambiences. Not very heavy to simplify its installation. Bespoke measures available under request.

**Installation and assembly:**

Follow instructions of the installation guide

**Electrical characteristics:**

**Max. Power:** 12 x 18W  
**Tension:** CE-UK: 220/240VAC US-JP: 100/125VAC  
**Frequency:** 50/60Hz  
Dimmer not included / LED bulb non dimmable

**Recommended Bulb**

Bulb not included	Bulb reference
<b>CE:</b> 12 x G9 Led 3W 220V (190Lm)	01089407
<b>US:</b> 12 x G9 Led 3W 110V (190Lm)	

**Certificates:**

CE, SASO  
UL

**Physical characteristics:**

1 Box / 111 x 82 x 82 cm / 0,746 m3  
1 Box / 43 3/4 x 32 1/4 x 32 1/4 inches / 45503 in3  
Gross weight 36 Kg. / Net weight 8,3 Kg.

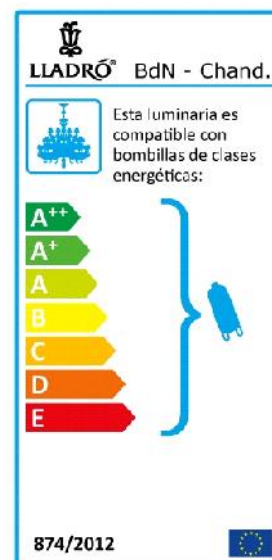

**Sketch**

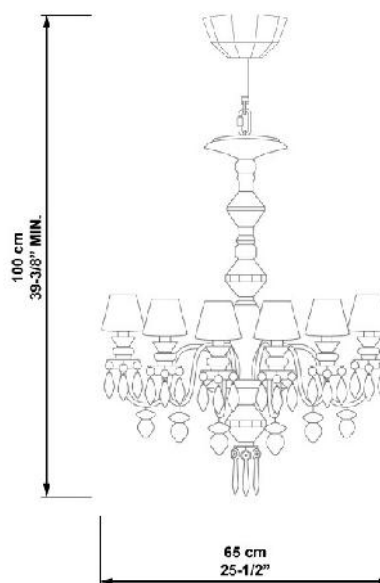

# Technical data sheet

**CE:** Ref 01023231 - UPC/EAN 737859232312  
**UK:** Ref 01023231 - UPC/EAN 737859232312  
**US:** Ref 01023232 - UPC/EAN 737859232312  
**JP:** Ref 01023233 - UPC/EAN 737859232312

**Description:**

**Belle de Nuit - Chandelier 40 lights - green**  
**Belle de Nuit - Chandelier 40 luces - verde**

**Collection:**

*BELLE DE NUIT*

**Mounting:**

Chandelier

**Environment:**

Chandelier entirely made of porcelain. Made in different finishes to match all decorative ambiances. Not very heavy to simplify its installation. Bespoke measures available under request.

**Installation and assembly:**

Follow instructions of the installation guide

**Electrical characteristics:**

**Max. Power:** 40 x 18W  
**Tension:** CE-UK: 220/240VAC US-JP: 100/125VAC  
**Frequency:** 50/60Hz  
 Dimmer not included / LED bulb non dimmable

**Recommended Bulb**

Bulb not included	Bulb reference
<b>CE:</b> 40 x G9 Led 3W 220V (190Lm)	01089407
<b>US:</b> 40 x G9 Led 3W 110V (190Lm)	

**Certificates:**

CE, SASO  
UL

**Physical characteristics:**

1 Box / 140 x 119 x 119 cm / 1,983 m<sup>3</sup>  
 1 Box / 55 x 46 3/4 x 46 3/4 inches / 120206 in<sup>3</sup>  
 Gross weight 129,6 kg. / Net weight 27,4 kg.



**Sketch**

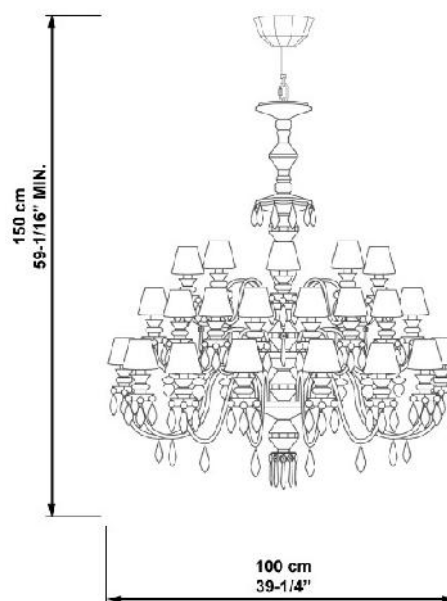

# Technical data sheet

**CE:** Ref 01023234 - UPC/EAN 737859232343  
**UK:** Ref 01023234 - UPC/EAN 737859232343  
**US:** Ref 01023235 - UPC/EAN 737859232343  
**JP:** Ref 01023236 - UPC/EAN 737859232343

**Description:**

**Belle de Nuit -Chandelier 24 lights - green**  
**Belle de Nuit - Chandelier 24 luces - verde**

**Collection:**

**BELLE DE NUIT**

**Mounting:**

Chandelier

**Environment:**

Chandelier entirely made of porcelain. Made in different finishes to match all decorative ambiences. Not very heavy to simplify its installation. Bespoke measures available under request.

**Installation and assembly:**

Follow instructions of the installation guide

**Electrical characteristics:**

**Max. Power:** 24 x 18W  
**Tension:** CE-UK: 220/240VAC US-JP: 100/125VAC  
**Frequency:** 50/60Hz  
 Dimmer not included / LED bulb non dimmable

**Recommended Bulb**

Bulb not included	<b>Bulb reference</b>
<b>CE:</b> 24 x G9 Led 3W 220V (190Lm)	1089407
<b>US:</b> 24 x G9 Led 3W 110V (190Lm)	

**Certificates:**

CE, SASO  
UL

**Physical characteristics:**

1 Box / 135 x 105 x 105 cm / 1,488 m3  
 1 Box / 53 1/4 x 41 1/4 x 41 1/4 inches / 90608 in3  
 Gross weight 44,1 kg. / Net weight 21,2 kg.

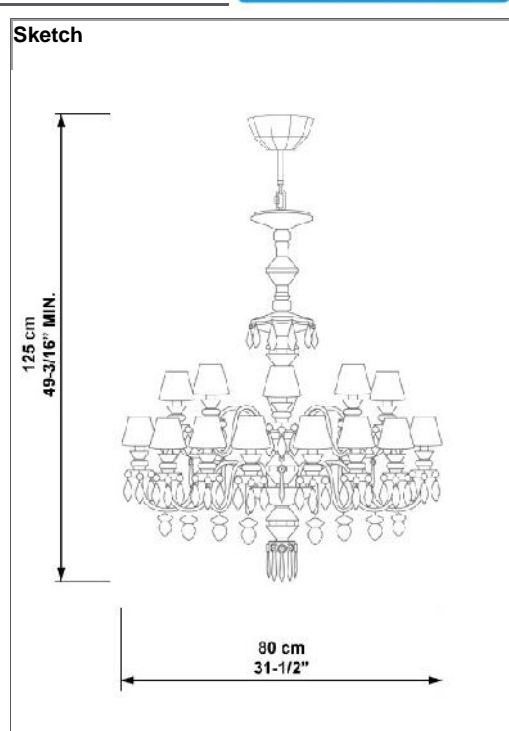
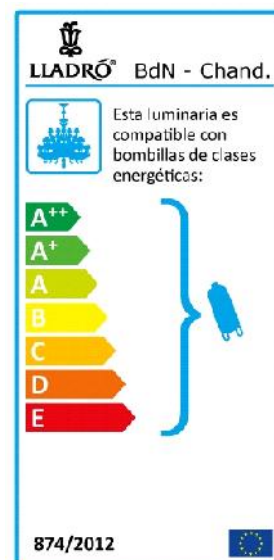



# Technical data sheet

**CE:** Ref 01023237 - UPC/EAN 737859232374  
**UK:** Ref 01023237 - UPC/EAN 737859232374  
**US:** Ref 01023238 - UPC/EAN 737859232374  
**JP:** Ref 01023239 - UPC/EAN 737859232374

**Description:**

**Belle de Nuit - Wall lamp with 2 lights - green**  
**Belle de Nuit - Aplique de pared con 2 luces - verde**

**Collection:**

**BELLE DE NUIT**

**Mounting:**

Wall light

**Environment:**

Wall lamp made of porcelain with decorative back mirror to enhance light effect. Made in different finishes to match all decorative ambiances. Easy to fit for a fast installation. Bespoke measures available under request.

**Installation and assembly:**

Follow instructions of the installation guide

**Electrical characteristics:**

**Max. Power:** 2 x 18W  
**Tension:** CE-UK: 220/240VAC US-JP: 100/125VAC  
**Frequency:** 50/60Hz  
 Dimmer not included / LED bulb non dimmable

**Recommended Bulb**

Bulb not included	<b>Bulb reference</b>
<b>CE:</b> 2 x G9 Led 3W 220V (190Lm)	1089407
<b>US:</b> 2 x G9 Led 3W 110V (190Lm)	

**Certificates:**

CE, SASO

**Physical characteristics:**

1 Box / 26,2 x 40,8 x 41,3 cm / 0,044 m3  
 1 Box / 10 1/4 x 16 x 16 1/4 inches / 2665 in3  
 Gross weight 3,1 kg. / Net weight 1,8 kg.



**Sketch**

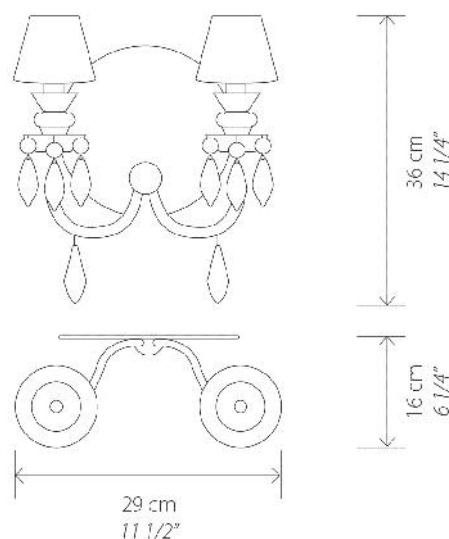

# Technical data sheet

**CE:** Ref 01023240 - UPC/EAN 737859232404  
**UK:** Ref 01023241 - UPC/EAN 737859232404  
**US:** Ref 01023242 - UPC/EAN 737859232404  
**JP:** Ref 01023243 - UPC/EAN 737859232404

**Description:**

**Belle de Nuit - Table Lamp - green**  
**Belle de Nuit - Lámpara de sobremesa - verde**

**Collection:**

**BELLE DE NUIT**

**Mounting:**

Table lamp

**Environment:**

Table lamp body in porcelain. Available in different finishes to match all decorative ambiances

**Installation and assembly:**

Follow instructions of the installation guide

**Electrical characteristics:**

**Max. Power:** 1 x 18W  
**Tension:** CE-UK: 220/240VAC US-JP: 100/125VAC  
**Frequency:** 50/60Hz  
 Dimmer not included

**Recommended Bulb**

Bulb not included	<b>Bulb reference</b>
<b>CE:</b> 1 x E27 LED 6W (600 Lm)	01089432
<b>US:</b> 1 x E26 LED 6W (600 Lm)	

**Certificates:**

CE, SASO  
UL

**Physical characteristics:**

1 Box / 49,7 x 32,3 x 56,8 cm / 0,091 m3  
 1 Box / 19 1/2 x 12 3/4 x 22 1/4 inches / 5532 in3  
 Gross weight 3,3 kg. / Net weight 1,3 kg.

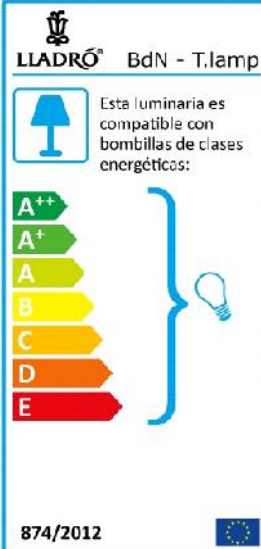
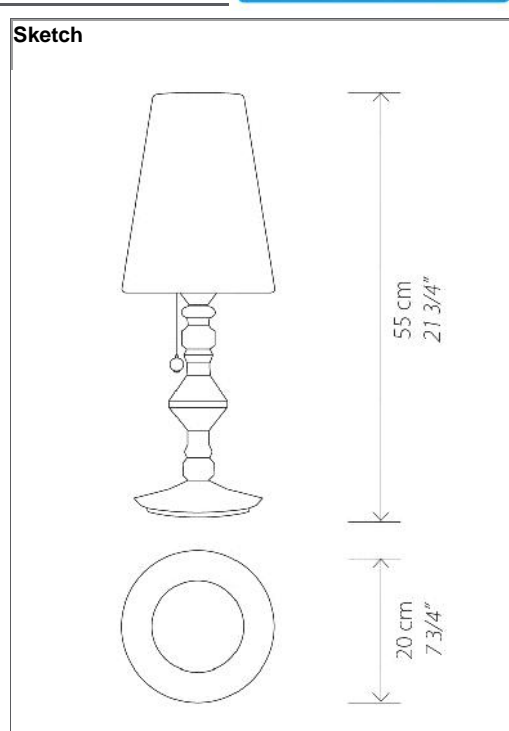
# Technical data sheet

**CE:** Ref 01023244 - UPC/EAN 737859232442  
**UK:** Ref 01023245 - UPC/EAN 737859232442  
**US:** Ref 01023246 - UPC/EAN 737859232442  
**JP:** Ref 01023247 - UPC/EAN 737859232442

**Description:**

**Belle de Nuit - Lithophane Table Lamp - green**  
**Belle de Nuit - Lámpara de sobremesa con Litofanía - verde**

**Collection:**

*BELLE DE NUIT*

**Mounting:**

Table lamp

**Environment:**

Both lamp body and lampshade are made of porcelain. Available in different finishes to match all decorative ambiances.

**Installation and assembly:**

Follow instructions of the installation guide

**Electrical characteristics:**

**Max. Power:** 1 x 18W  
**Tension:** CE-UK: 220/240VAC US-JP: 100/125VAC  
**Frequency:** 50/60Hz  
 Dimmer not included / LED bulb non dimmable

**Recommended Bulb**

	<b>Bulb reference</b>
<b>Bulb not included</b>	
<b>CE:</b> 1 x G9 Led 3W 220V (190Lm)	01089407
<b>US:</b> 1 x Spherical Light bulb LED E12 4W	

**Certificates:**

CE, SASO  
UL

**Physical characteristics:**

1 Box / 17,9 x 24,9 x 42,3 cm / 0,019 m<sup>3</sup>  
 1 Box / 7 x 9 3/4 x 16 3/4 inches / 1143 in<sup>3</sup>  
 Gross weight 1,4 kg. / Net weight 0,7 kg.



**Sketch**

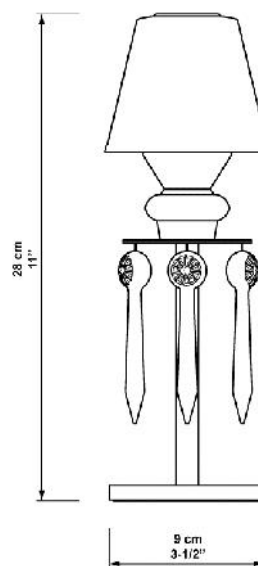

# Technical data sheet

**CE:** Ref 01023248 - UPC/EAN 737859232480  
**UK:** Ref 01023248 - UPC/EAN 737859232480  
**US:** Ref 01023249 - UPC/EAN 737859232480  
**JP:** Ref 01023250 - UPC/EAN 737859232480

**Description:**

**Belle de Nuit -Chandelier 12 lights - blue**  
**Belle de Nuit - Chandelier 12 luces - azul**

**Collection:**

**BELLE DE NUIT**

**Mounting:**

Chandelier

**Environment:**

Chandelier entirely made of porcelain. Made in different finishes to match all decorative ambiences. Not very heavy to simplify its installation. Bespoke measures available under request.

**Installation and assembly:**

Follow instructions of the installation guide

**Electrical characteristics:**

**Max. Power:** 12 x 18W  
**Tension:** CE-UK: 220/240VAC US-JP: 100/125VAC  
**Frequency:** 50/60Hz  
 Dimmer not included / LED bulb non dimmable

**Recommended Bulb**

Bulb not included	<b>Bulb reference</b>
<b>CE:</b> 12 x G9 Led 3W 220V (190Lm)	1089407
<b>US:</b> 12 x G9 Led 3W 110V (190Lm)	

**Certificates:**

CE, SASO  
UL

**Physical characteristics:**

1 Box / 111 x 82 x 82 cm / 0,746 m3  
 1 Box / 43 3/4 x 32 1/4 x 32 1/4 inches / 45503 in3  
 Gross weight 36 Kg. / Net weight 8,3 Kg.



**LLADRÓ** BdN - Chand.

Esta luminaria es compatible con bombillas de clases energéticas:

A++  
A+  
A  
B  
C  
D  
E

874/2012



**Sketch**

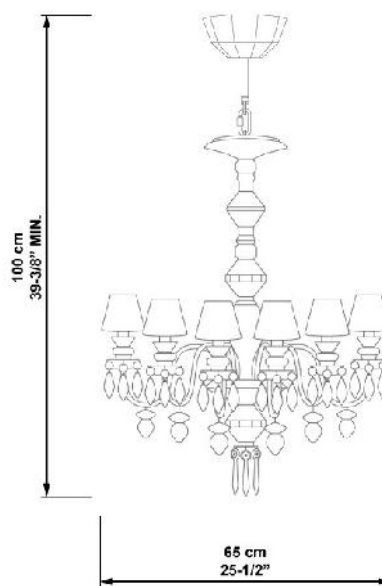

# Technical data sheet

<b>CE:</b>	Ref 01023251 - UPC/EAN 737859232510
<b>UK:</b>	Ref 01023251 - UPC/EAN 737859232510
<b>US:</b>	Ref 01023252 - UPC/EAN 737859232510
<b>JP:</b>	Ref 01023253 - UPC/EAN 737859232510

**Description:** Belle de Nuit - Chandelier 40 lights - blue  
Belle de Nuit - Chandelier 40 luces - azul

**Collection:** *BELLE DE NUIT*

**Mounting:** Chandelier

**Environment:** Chandelier entirely made of porcelain. Made in different finishes to match all decorative ambiances. Not very heavy to simplify its installation. Bespoke measures available under request.

**Installation and assembly:** Follow instructions of the installation guide

**Electrical characteristics:**  
**Max. Power:** 40 x 18W  
**Tension:** CE-UK: 220/240VAC US-JP: 100/125VAC  
**Frequency:** 50/60Hz  
 Dimmer not included / LED bulb non dimmable

Recommended Bulb	Bulb reference
<b>CE:</b> 40 x G9 Led 3W 220V (190Lm)	01089407
<b>US:</b> 40 x G9 Led 3W 110V (190Lm)	

**Certificates:** CE, SASO  
UL

**Physical characteristics:**  
 1 Box / 202,67 x 100 x 100 cm / 2,027 m<sup>3</sup>  
 1 Box / 79 3/4 x 39 1/4 x 39 1/4 inches / 122860 in<sup>3</sup>  
 Gross weight 129,6 kg. / Net weight 27,4 kg.



Sketch

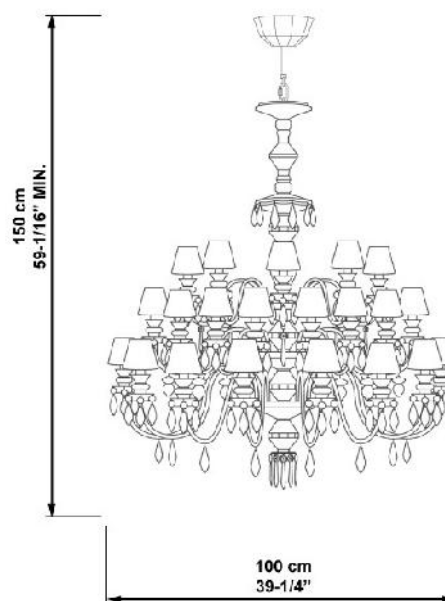

# Technical data sheet

<b>CE:</b>	Ref 01023254 - UPC/EAN 737859232541
<b>UK:</b>	Ref 01023254 - UPC/EAN 737859232541
<b>US:</b>	Ref 01023255 - UPC/EAN 737859232541
<b>JP:</b>	Ref 01023256 - UPC/EAN 737859232541

## Description:

**Belle de Nuit -Chandelier 24 lights - blue**  
**Belle de Nuit - Chandelier 24 luces - azul**

## Collection:

**BELLE DE NUIT**

## Mounting:

Chandelier

## Environment:

Chandelier entirely made of porcelain. Made in different finishes to match all decorative ambiences. Not very heavy to simplify its installation. Bespoke measures available under request.

## Installation and assembly:

Follow instructions of the installation guide

## Electrical characteristics:

**Max. Power:** 24 x 18W  
**Tension:** CE-UK: 220/240VAC US-JP: 100/125VAC  
**Frequency:** 50/60Hz  
Dimmer not included / LED bulb non dimmable

## Recommended Bulb

Bulb not included	Bulb reference
<b>CE:</b> 24 x G9 Led 3W 220V (190Lm)	1089407
<b>US:</b> 24 x G9 Led 3W 110V (190Lm)	

## Certificates:

CE, SASO  
UL

## Physical characteristics:

1 Box / 135 x 105 x 105 cm / 1,488 m<sup>3</sup>  
1 Box / 53 1/4 x 41 1/4 x 41 1/4 inches / 90608 in<sup>3</sup>  
Gross weight 44,1 kg. / Net weight 21,2 kg.

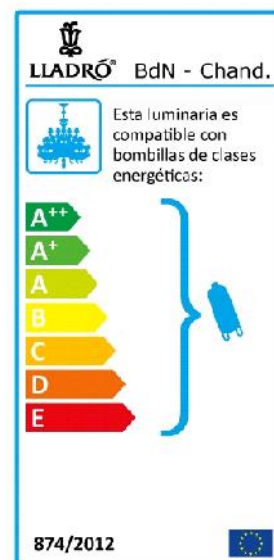

## Sketch

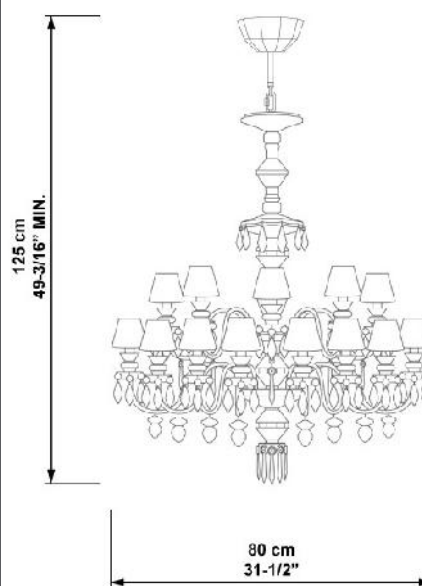

# Technical data sheet

**CE:** Ref 01023257 - UPC/EAN 737859232572  
**UK:** Ref 01023257 - UPC/EAN 737859232572  
**US:** Ref 01023258 - UPC/EAN 737859232572  
**JP:** Ref 01023259 - UPC/EAN 737859232572

**Description:**

**Belle de Nuit - Wall 2 lights - blue**  
**Belle de Nuit - Applique pared 2 luces - azul**

**Collection:**

**BELLE DE NUIT**

**Mounting:**

Wall light

**Environment:**

Wall lamp made of porcelain with decorative back mirror to enhance light effect. Made in different finishes to match all decorative ambiances. Easy to fit for a fast installation. Bespoke measures available under request.

**Installation and assembly:**

Follow instructions of the installation guide

**Electrical characteristics:**

**Max. Power:** 2 x 18W  
**Tension:** CE-UK: 220/240VAC US-JP: 100/125VAC  
**Frequency:** 50/60Hz  
 Dimmer not included / LED bulb non dimmable

**Recommended Bulb**

Bulb not included	<b>Bulb reference</b>
<b>CE:</b> 2 x G9 Led 3W 220V (190Lm)	1089407
<b>US:</b> 2 x G9 Led 3W 110V (190Lm)	

**Certificates:**

CE, SASO

**Physical characteristics:**

1 Box / 26,2 x 40,8 x 41,3 cm / 0,044 m3  
 1 Box / 10 1/4 x 16 x 16 1/4 inches / 2665 in3  
 Gross weight 3,1 kg. / Net weight 1,8 kg.

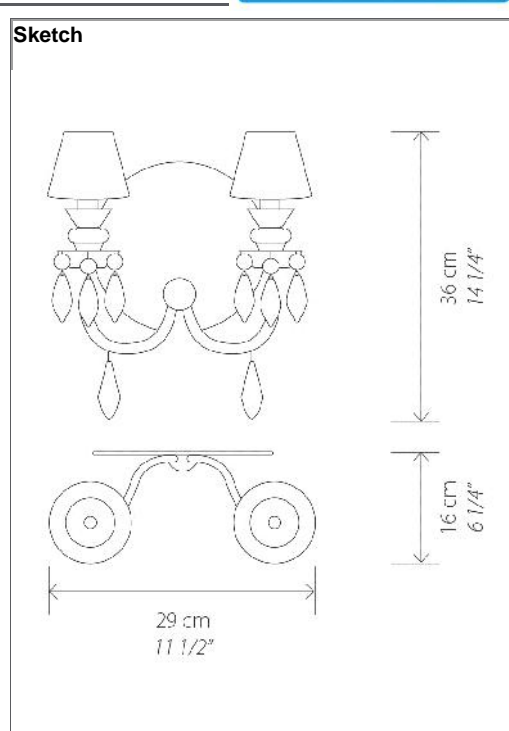
# Technical data sheet

<b>CE:</b>	Ref 01023260 - UPC/EAN 737859232602
<b>UK:</b>	Ref 01023261 - UPC/EAN 737859232602
<b>US:</b>	Ref 01023262 - UPC/EAN 737859232602
<b>JP:</b>	Ref 01023263 - UPC/EAN 737859232602

**Description:**

**Belle de Nuit - Table Lamp - blue**  
**Belle de Nuit - Lámpara de sobremesa - azul**

**Collection:**

**BELLE DE NUIT**

**Mounting:**

Table lamp

**Environment:**

Table lamp body in porcelain. Available in different finishes to match all decorative ambiances

**Installation and assembly:**

Follow instructions of the installation guide

**Electrical characteristics:**

**Max. Power:** 1 x 18W  
**Tension:** CE-UK: 220/240VAC US-JP: 100/125VAC  
**Frequency:** 50/60Hz  
Dimmer not included

**Recommended Bulb**

	Bulb not included	Bulb reference
<b>CE:</b>	1 x E27 LED 6W (600 Lm)	01089432
<b>US:</b>	1 x E26 LED 6W (600 Lm)	

**Certificates:**

CE, SASO  
UL

**Physical characteristics:**

1 Box / 49,7 x 32,3 x 56,8 cm / 0,091 m3  
1 Box / 19 1/2 x 12 3/4 x 22 1/4 inches / 5532 in3  
Gross weight 3,3 kg. / Net weight 1,3 kg.

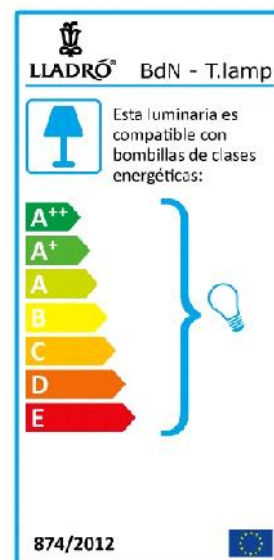

**Sketch**

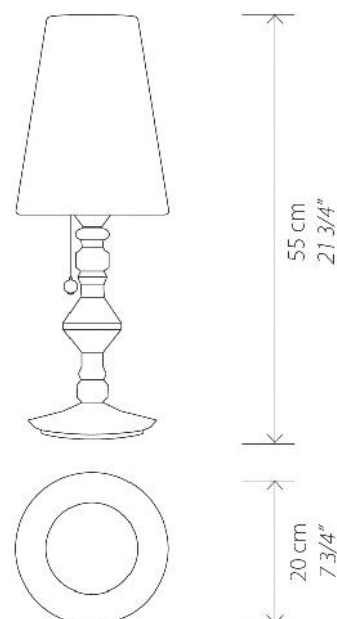



# Technical data sheet

**CE:** Ref 01023264 - UPC/EAN 737859232640  
**UK:** Ref 01023265 - UPC/EAN 737859232640  
**US:** Ref 01023266 - UPC/EAN 737859232640  
**JP:** Ref 01023267 - UPC/EAN 737859232640

**Description:**

**Belle de Nuit - Lithophane Table Lamp - blue**  
**Belle de Nuit - Lámpara de mesa con Litofanía - azul**

**Collection:**

*BELLE DE NUIT*

**Mounting:**

Table lamp

**Environment:**

Both lamp body and lampshade are made of porcelain. Available in different finishes to match all decorative ambiances.

**Installation and assembly:**

Follow instructions of the installation guide

**Electrical characteristics:**

**Max. Power:** 1 x 18W  
**Tension:** CE-UK: 220/240VAC US-JP: 100/125VAC  
**Frequency:** 50/60Hz  
 Dimmer not included / LED bulb non dimmable

**Recommended Bulb**

	<b>Bulb reference</b>
<b>Bulb not included</b>	
<b>CE:</b> 1 x G9 Led 3W 220V (190Lm)	1089407
<b>US:</b> 1 x E12 Dimmable candle Led 4W	

**Certificates:**

CE, SASO  
 UL certification

**Physical characteristics:**

1 Box / 17,9 x 24,9 x 42,3 cm / 0,019 m3  
 1 Box / 7 x 9 3/4 x 16 3/4 inches / 1143 in3  
 Gross weight 1,4 kg. / Net weight 0,7 kg.



**Sketch**

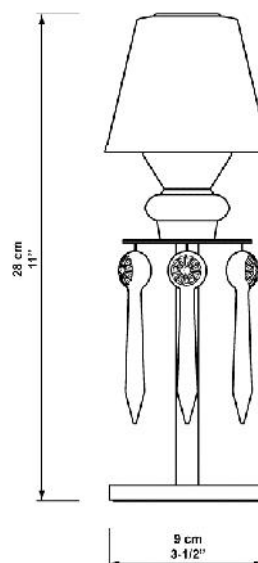

# Technical data sheet

**CE:** Ref 01023268 - UPC/EAN 737859232688  
**UK:** Ref 01023268 - UPC/EAN 737859232688  
**US:** Ref 01023269 - UPC/EAN 737859232688  
**JP:** Ref 01023270 - UPC/EAN 737859232688

**Description:**

**Belle de Nuit - Chandelier 12 lights - pink**  
**Belle de Nuit - Chandelier 12 luces - rosa**

**Collection:**

**BELLE DE NUIT**

**Mounting:**

Chandelier

**Environment:**

Chandelier entirely made of porcelain. Made in different finishes to match all decorative ambiences. Not very heavy to simplify its installation. Bespoke measures available under request.

**Installation and assembly:**

Follow instructions of the installation guide

**Electrical characteristics:**

**Max. Power:** 12 X 18W  
**Tension:** CE-UK: 220/240VAC US-JP: 100/125VAC  
**Frequency:** 50/60Hz  
 Dimmer not included / LED bulb non dimmable

**Recommended Bulb**

Bulb not included	<b>Bulb reference</b>
<b>CE:</b> 12 x G9 Led 3W 220V (190Lm)	01089407
<b>US:</b> 12 x G9 Led 3W 110V (190Lm)	

**Certificates:**

CE, SASO  
UL

**Physical characteristics:**

1 Box / 111 x 82 x 82 cm / 0,746 m3  
 1 Box / 43 3/4 x 32 1/4 x 32 1/4 inches / 45503 in3  
 Gross weight 36 Kg. / Net weight 8,3 Kg.



**LLADRÓ** BdN - Chand.

Esta luminaria es compatible con bombillas de clases energéticas:

A++  
A+  
A  
B  
C  
D  
E

874/2012 

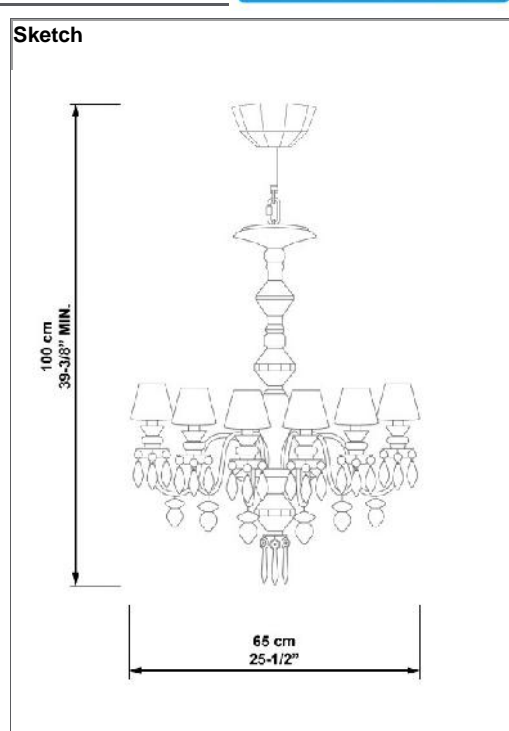

# Technical data sheet

**CE:** Ref 01023271 - UPC/EAN 737859232718  
**UK:** Ref 01023271 - UPC/EAN 737859232718  
**US:** Ref 01023272 - UPC/EAN 737859232718  
**JP:** Ref 01023273 - UPC/EAN 737859232718

**Description:**

**Belle de Nuit - Chandelier 40 lights - pink**  
**Belle de Nuit - Chandelier 40 luces - rosa**

**Collection:**

**BELLE DE NUIT**

**Mounting:**

Chandelier

**Environment:**

Chandelier entirely made of porcelain. Made in different finishes to match all decorative ambiances. Not very heavy to simplify its installation. Bespoke measures available under request.

**Installation and assembly:**

Follow instructions of the installation guide

**Electrical characteristics:**

**Max. Power:** 40 x 18W  
**Tension:** CE-UK: 220/240VAC US-JP: 100/125VAC  
**Frequency:** 50/60Hz  
 Dimmer not included / LED bulb non dimmable

**Recommended Bulb**

Bulb not included	Bulb reference
<b>CE:</b> 40 x G9 Led 3W 220V (190Lm)	01089407
<b>US:</b> 40 x G9 Led 3W 110V (190Lm)	

**Certificates:**

CE, SASO  
UL

**Physical characteristics:**

1 Box / 140 x 119 x 119 cm / 1,983 m3  
 1 Box / 55 x 46 3/4 x 46 3/4 inches / 120206 in3  
 Gross weight 129,6 kg. / Net weight 27,4 kg.



**Sketch**

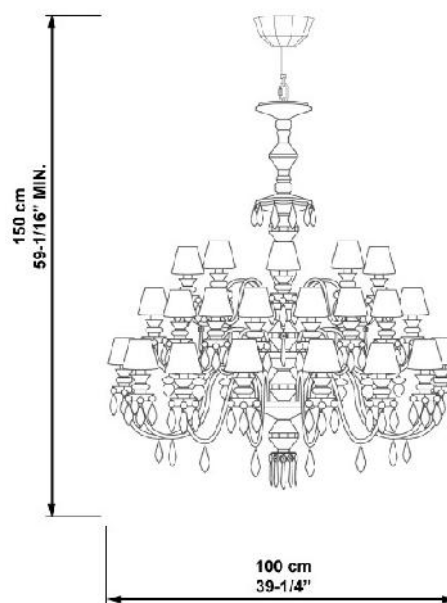

# Technical data sheet

<b>CE:</b>	Ref 01023274 - UPC/EAN 737859232749
<b>UK:</b>	Ref 01023274 - UPC/EAN 737859232749
<b>US:</b>	Ref 01023275 - UPC/EAN 737859232749
<b>JP:</b>	Ref 01023276 - UPC/EAN 737859232749

**Description:** Belle de Nuit - Chandelier 24 lights - pink  
Belle de Nuit - Chandelier 24 luces - rosa

**Collection:** BELLE DE NUIT

**Mounting:** Chandelier

**Environment:** Chandelier entirely made of porcelain. Made in different finishes to match all decorative ambiences. Not very heavy to simplify its installation. Bespoke measures available under request.

**Installation and assembly:** Follow instructions of the installation guide

**Electrical characteristics:**  
**Max. Power:** 24 x 18W  
**Tension:** CE-UK: 220/240VAC US-JP: 100/125VAC  
**Frequency:** 50/60Hz  
 Dimmer not included / LED bulb non dimmable

**Recommended Bulb**

Bulb	Bulb reference
Bulb not included	
<b>CE:</b> 24 x G9 Led 3W 220V (190Lm)	01089407
<b>US:</b> 24 x G9 Led 3W 110V (190Lm)	

**Certificates:** CE, SASO, UL

**Physical characteristics:**  
 1 Box / 135 x 105 x 105 cm / 1,488 m3  
 1 Box / 53 1/4 x 41 1/4 x 41 1/4 inches / 90608 in3  
 Gross weight 44,1 kg. / Net weight 21,2 kg.

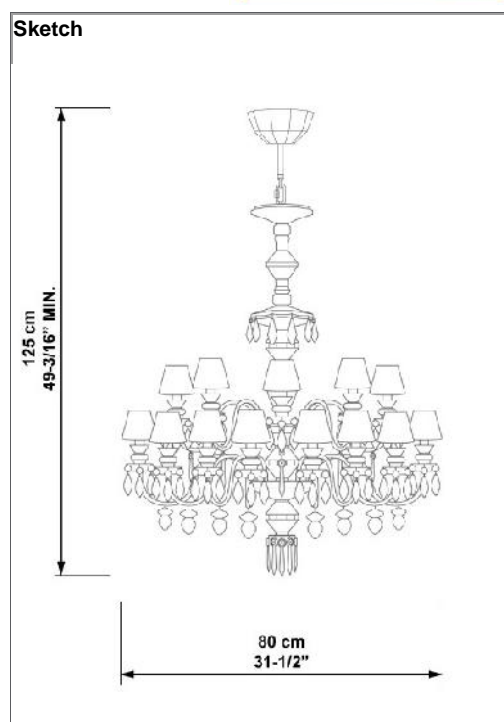
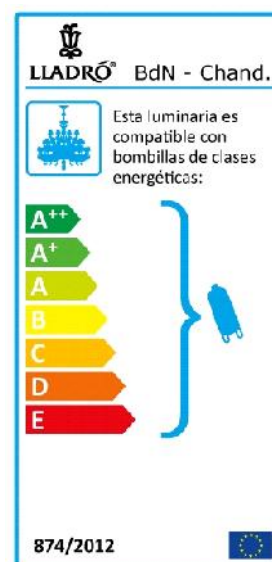

# Technical data sheet

**CE:** Ref 01023277 - UPC/EAN 737859232770  
**UK:** Ref 01023277 - UPC/EAN 737859232770  
**US:** Ref 01023278 - UPC/EAN 737859232770  
**JP:** Ref 01023279 - UPC/EAN 737859232770

**Description:**

**Belle de Nuit - Wall 2 lights - pink**  
**Belle de Nuit - Applique pared 2 luces - rosa**

**Collection:**

**BELLE DE NUIT**

**Mounting:**

Wall light

**Environment:**

Wall lamp made of porcelain with decorative back mirror to enhance light effect. Made in different finishes to match all decorative ambiances. Easy to fit for a fast installation. Bespoke measures available under request.

**Installation and assembly:**

Follow instructions of the installation guide

**Electrical characteristics:**

**Max. Power:** 40W  
**Tension:** CE-UK: 220/240VAC US-JP: 100/125VAC  
**Frequency:** 50/60Hz  
 Dimmer not included / LED bulb non dimmable

**Recommended Bulb**

Bulb not included **Bulb reference**  
**CE:** 2 x G9 Led 3W **1089407**  
**US:**

**Certificates:**

CE, SASO

**Physical characteristics:**

1 Box / 26,2 x 40,8 x 41,3 cm / 0,044 m3  
 1 Box / 10 1/4 x 16 x 16 1/4 inches / 2665 in3  
 Gross weight 3,1 kg. / Net weight 1,8 kg.



**Sketch**

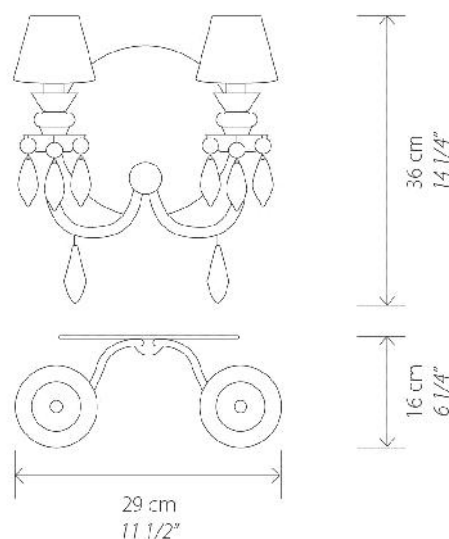

# Technical data sheet

<b>CE:</b>	Ref 01023280 - UPC/EAN 737859232800
<b>UK:</b>	Ref 01023281 - UPC/EAN 737859232800
<b>US:</b>	Ref 01023282 - UPC/EAN 737859232800
<b>JP:</b>	Ref 01023283 - UPC/EAN 737859232800

<b>Description:</b>	<b>Belle de Nuit - Table Lamp - pink</b> <b>Belle de Nuit - Lámpara de sobremesa - rosa</b>
<b>Collection:</b>	<b>BELLE DE NUIT</b>
<b>Mounting:</b>	Table lamp
<b>Environment:</b>	Table lamp body in porcelain. Available in different finishes to match all decorative ambiances

<b>Installation and assembly:</b>	Follow instructions of the installation guide	
<b>Electrical characteristics:</b>	<b>Max. Power:</b> 1 x 18W <b>Tension:</b> CE-UK: 220/240VAC US-JP: 100/125VAC <b>Frequency:</b> 50/60Hz Dimmer not included	
<b>Recommended Bulb</b>	<b>Bulb not included</b> <b>CE:</b> 1 x E27 LED 6W (600 Lm) <b>US:</b> 1 x E26 LED 6W (600 Lm)	<b>Bulb reference</b> 01089432
<b>Certificates:</b>	CE. SASO UL	
<b>Physical characteristics:</b>	1 Box / 49,7 x 32,3 x 56,8 cm / 0,091 m3 1 Box / 19 1/2 x 12 3/4 x 22 1/4 inches / 5532 in3 Gross weight 3,3 kg. / Net weight 1,3 kg.	

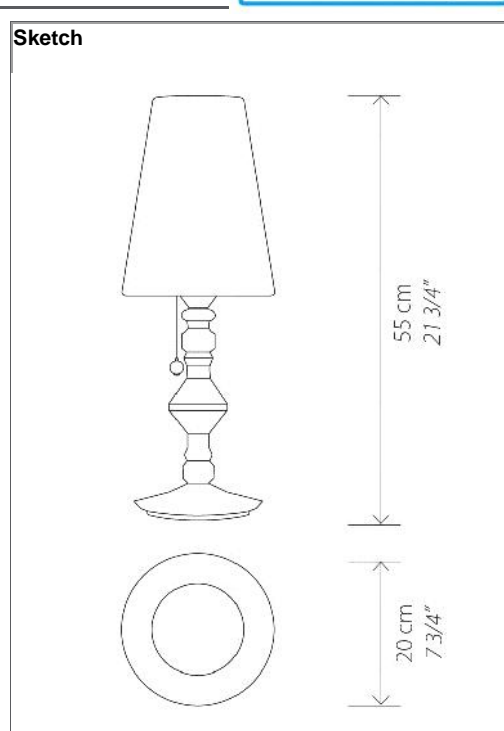
# Technical data sheet

<b>CE:</b>	Ref 01023284 - UPC/EAN 737859232848
<b>UK:</b>	Ref 01023285 - UPC/EAN 737859232848
<b>US:</b>	Ref 01023286 - UPC/EAN 737859232848
<b>JP:</b>	Ref 01023287 - UPC/EAN 737859232848

<b>Description:</b>	<b>Belle de Nuit - Lithophane Lamp - pink</b> <b>Belle de Nuit - Lámpara Litofanía - rosa</b>						
<b>Collection:</b>	<i>BELLE DE NUIT</i>						
<b>Mounting:</b>	Table lamp						
<b>Environment:</b>	Both lamp body and lampshade are made of porcelain. Available in different finishes to match all decorative ambiances.						
<b>Installation and assembly:</b>	Follow instructions of the installation guide						
<b>Electrical characteristics:</b>	<p><b>Max. Power:</b> 1 x 18W</p> <p><b>Tension:</b> CE-UK: 220/240VAC US-JP: 100/125VAC</p> <p><b>Frequency:</b> 50/60Hz</p> <p>Dimmer not included / LED bulb non dimmable</p>						
<b>Recommended Bulb</b>	<table> <thead> <tr> <th>Bulb not included</th> <th>Bulb reference</th> </tr> </thead> <tbody> <tr> <td><b>CE:</b> 1 x G9 Led 3W 220V (190Lm)</td> <td>1089407</td> </tr> <tr> <td><b>US:</b> 1 x Edison E12 Incandescent 40W (m</td> <td></td> </tr> </tbody> </table>	Bulb not included	Bulb reference	<b>CE:</b> 1 x G9 Led 3W 220V (190Lm)	1089407	<b>US:</b> 1 x Edison E12 Incandescent 40W (m	
Bulb not included	Bulb reference						
<b>CE:</b> 1 x G9 Led 3W 220V (190Lm)	1089407						
<b>US:</b> 1 x Edison E12 Incandescent 40W (m							
<b>Certificates:</b>	CE. SASO UL						
<b>Physical characteristics:</b>	<p>1 Box / 17,9 x 24,9 x 42,3 cm / 0,019 m3</p> <p>1 Box / 7 x 9 3/4 x 16 3/4 inches / 1143 in3</p> <p>Gross weight 1,4 kg. / Net weight 0,7 kg.</p>						



Sketch

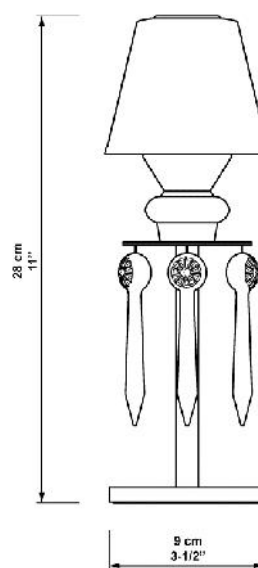

# Technical data sheet

<b>CE:</b>	Ref 01023288 - UPC/EAN 737859232886
<b>UK:</b>	Ref 01023288 - UPC/EAN 737859232886
<b>US:</b>	Ref 01023289 - UPC/EAN 737859232886
<b>JP:</b>	Ref 01023290 - UPC/EAN 737859232886

**Description:**

**Belle de Nuit - Chandelier 12 lights - multicolor**  
**Belle de Nuit - Chandelier 12 luces - multicolor**

**Collection:**

**BELLE DE NUIT**

**Mounting:**

Chandelier

**Environment:**

Chandelier entirely made of porcelain. Made in different finishes to match all decorative ambiences. Not very heavy to simplify its installation. Bespoke measures available under request.

**Installation and assembly:**

Follow instructions of the installation guide

**Electrical characteristics:**

**Max. Power:** 12 x 18W  
**Tension:** CE-UK: 220/240VAC US-JP: 100/125VAC  
**Frequency:** 50/60Hz  
Dimmer not included / LED bulb non dimmable

**Recommended Bulb**

Bulb not included	Bulb reference
<b>CE:</b> 12 x G9 Led 3W 220V (190Lm)	01089407
<b>US:</b> 12 x G9 Led 3W 110V (190Lm)	

**Certificates:**

CE, SASO  
UL

**Physical characteristics:**

1 Box / 111 x 82 x 82 cm / 0,746 m3  
1 Box / 43 3/4 x 32 1/4 x 32 1/4 inches / 45503 in3  
Gross weight 36 Kg. / Net weight 8,3 Kg.

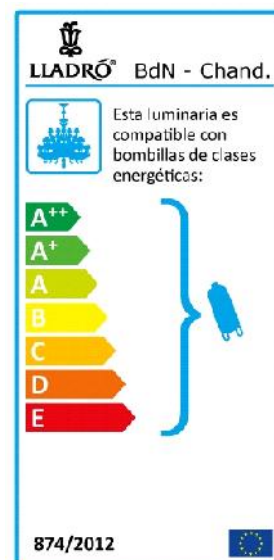

**Sketch**

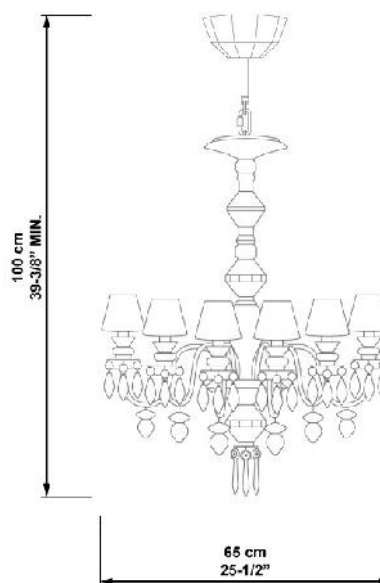



# Technical data sheet

<b>CE:</b>	Ref 01023291 - UPC/EAN 737859232916
<b>UK:</b>	Ref 01023291 - UPC/EAN 737859232916
<b>US:</b>	Ref 01023292 - UPC/EAN 737859232916
<b>JP:</b>	Ref 01023293 - UPC/EAN 737859232916

**Description:**

**Belle de Nuit - Chandelier 40 lights - multicolor**  
**Belle de Nuit - Chandelier 40 luces - multicolor**

**Collection:**

**BELLE DE NUIT**

**Mounting:**

Chandelier

**Environment:**

Chandelier entirely made of porcelain. Made in different finishes to match all decorative ambiances. Not very heavy to simplify its installation. Bespoke measures available under request.

**Installation and assembly:**

Follow instructions of the installation guide

**Electrical characteristics:**

**Max. Power:** 40 x 18W  
**Tension:** CE-UK: 220/240VAC US-JP: 100/125VAC  
**Frequency:** 50/60Hz  
Dimmer not included / LED bulb non dimmable

**Recommended Bulb**

Bulb not included	Bulb reference
<b>CE:</b> 40 x G9 Led 3W 220V (190Lm)	01089407
<b>US:</b> 40 x G9 Led 3W 110V (190Lm)	

**Certificates:**

CE, SASO  
UL

**Physical characteristics:**

1 Box / 140 x 119 x 119 cm / 1,983 m<sup>3</sup>  
1 Box / 55 x 46 3/4 x 46 3/4 inches / 120206 in<sup>3</sup>  
Gross weight 129,6 kg. / Net weight 27,4 kg.



**Sketch**

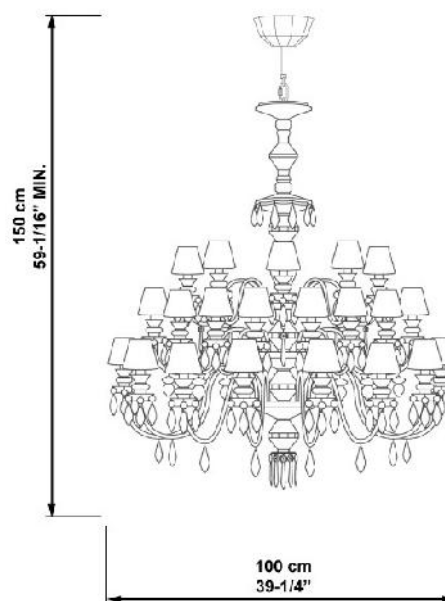

# Technical data sheet

**CE:** Ref 01023294 - UPC/EAN 737859232947  
**UK:** Ref 01023294 - UPC/EAN 737859232947  
**US:** Ref 01023295 - UPC/EAN 737859232947  
**JP:** Ref 01023296 - UPC/EAN 737859232947

**Description:**

**Belle de Nuit - Chandelier 24 lights - multicolor**  
**Belle de Nuit - Chandelier 24 luces - multicolor**

**Collection:**

**BELLE DE NUIT**

**Mounting:**

Chandelier

**Environment:**

Chandelier entirely made of porcelain. Made in different finishes to match all decorative ambiences. Not very heavy to simplify its installation. Bespoke measures available under request.

**Installation and assembly:**

Follow instructions of the installation guide

**Electrical characteristics:**

**Max. Power:** 24 x 18W  
**Tension:** CE-UK: 220/240VAC US-JP: 100/125VAC  
**Frequency:** 50/60Hz  
 Dimmer not included / LED bulb non dimmable

**Recommended Bulb**

Bulb not included	<b>Bulb reference</b>
<b>CE:</b> 24 x G9 Led 3W 220V (190Lm)	01089407
<b>US:</b> 24 x G9 Led 3W 110V (190Lm)	

**Certificates:**

CE, SASO  
UL

**Physical characteristics:**

1 Box / 135 x 105 x 105 cm / 1,488 m3  
 1 Box / 53 1/4 x 41 1/4 x 41 1/4 inches / 90608 in3  
 Gross weight 44,1 kg. / Net weight 21,2 kg.



**LLADRÓ** BdN - Chand.

Esta luminaria es compatible con bombillas de clases energéticas:

A++  
A+  
A  
B  
C  
D  
E

874/2012 

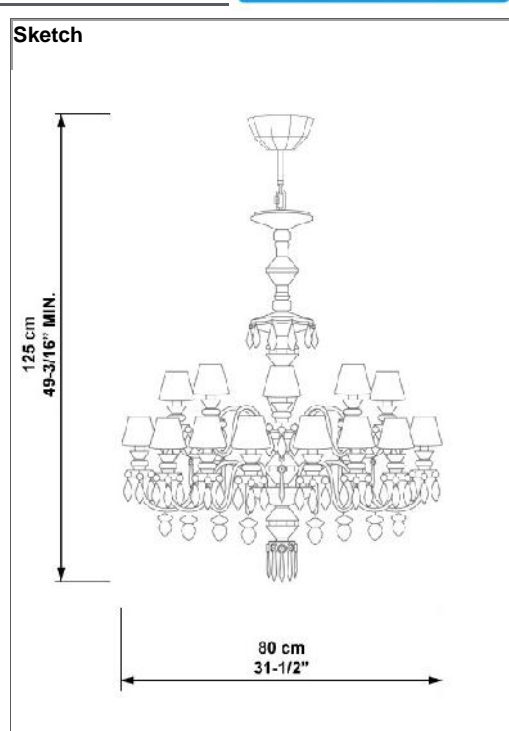

# Technical data sheet

**CE:** Ref 01023297 - UPC/EAN 737859232978  
**UK:** Ref 01023297 - UPC/EAN 737859232978  
**US:** Ref 01023298 - UPC/EAN 737859232978  
**JP:** Ref 01023299 - UPC/EAN 737859232978

**Description:**

**Belle de Nuit - Wall 2 lights - multicolor**  
**Belle de Nuit - Aplique pared 2 luces - multicolor**

**Collection:**

**BELLE DE NUIT**

**Mounting:**

Wall light

**Environment:**

Wall lamp made of porcelain with decorative back mirror to enhance light effect. Made in different finishes to match all decorative ambiances. Easy to fit for a fast installation. Bespoke measures available under request.

**Installation and assembly:**

Follow instructions of the installation guide

**Electrical characteristics:**

**Max. Power:** 2 x 18W  
**Tension:** CE-UK: 220/240VAC US-JP: 100/125VAC  
**Frequency:** 50/60Hz  
 Dimmer not included / LED bulb non dimmable

**Recommended Bulb**

Bulb not included	<b>Bulb reference</b>
<b>CE:</b> 2 x G9 Led 3W 220V (190Lm)	1089407
<b>US:</b> 2 x G9 Led 3W 110V (190Lm)	

**Certificates:**

CE, SASO

**Physical characteristics:**

1 Box / 26,2 x 40,8 x 41,3 cm / 0,044 m3  
 1 Box / 10 1/4 x 16 x 16 1/4 inches / 2665 in3  
 Gross weight 3,1 kg. / Net weight 1,8 kg.



**Sketch**

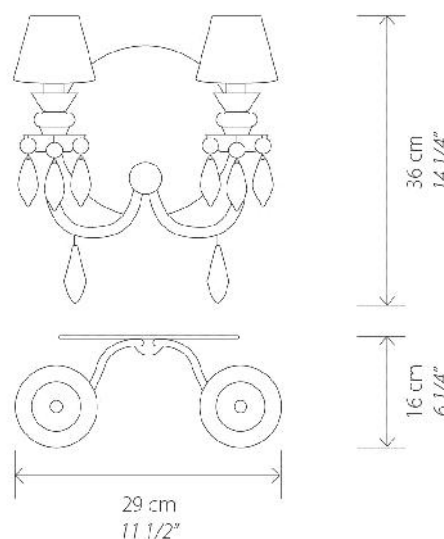

# Technical data sheet

**CE:** Ref 01023300 - UPC/EAN 737859233005  
**UK:** Ref 01023301 - UPC/EAN 737859233005  
**US:** Ref 01023302 - UPC/EAN 737859233005  
**JP:** Ref 01023303 - UPC/EAN 737859233005

**Description:**

**Belle de Nuit - Table Lamp - multicolor**  
**Belle de Nuit - Lámpara de sobremesa - multicolor**

**Collection:**

**BELLE DE NUIT**

**Mounting:**

Table lamp

**Environment:**

Table lamp body in porcelain. Available in different finishes to match all decorative ambiances

**Installation and assembly:**

Follow instructions of the installation guide

**Electrical characteristics:**

**Max. Power:** 1 x 18W  
**Tension:** CE-UK: 220/240VAC US-JP: 100/125VAC  
**Frequency:** 50/60Hz  
 Dimmer not included

**Recommended Bulb**

Bulb not included	<b>Bulb reference</b>
<b>CE:</b> 1 x E27 LED 6W (600 Lm)	01089432
<b>US:</b> 1 x E26 LED 6W (600 Lm)	

**Certificates:**

CE, SASO  
 UL

**Physical characteristics:**

1 Box / 49,7 x 32,3 x 56,8 cm / 0,091 m3  
 1 Box / 19 1/2 x 12 3/4 x 22 1/4 inches / 5532 in3  
 Gross weight 3,3 kg. / Net weight 1,3 kg.

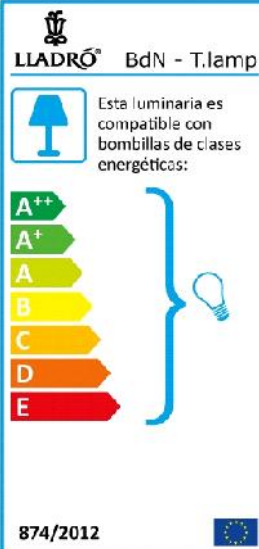

**LLADRÓ** BdN - T.lamp

Esta luminaria es compatible con bombillas de clases energéticas:

A++  
 A+  
 A  
 B  
 C  
 D  
 E

874/2012

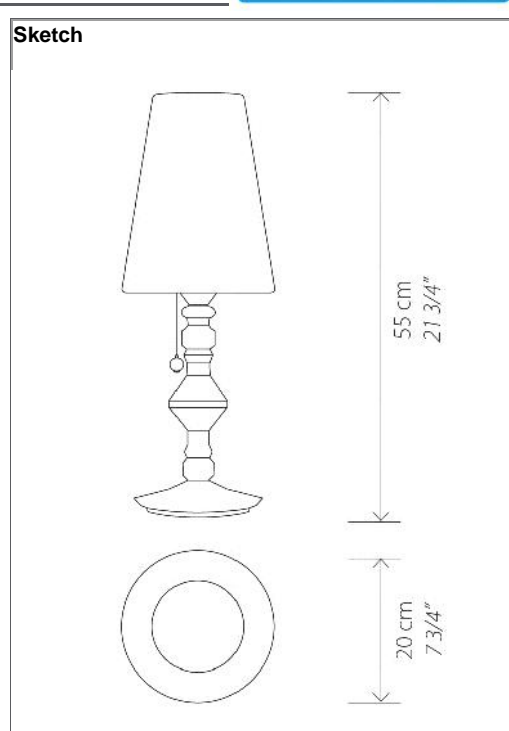

# Technical data sheet

<b>CE:</b>	Ref 01023308 - UPC/EAN 737859233081
<b>UK:</b>	Ref 01023308 - UPC/EAN 737859233081
<b>US:</b>	Ref 01023309 - UPC/EAN 737859233081
<b>JP:</b>	Ref 01023310 - UPC/EAN 737859233081

**Description:**

**Belle de Nuit - Chandelier 12 lights - gold**  
**Belle de Nuit - Chandelier 12 luces - oro**

**Collection:**

**BELLE DE NUIT**

**Mounting:**

Chandelier

**Environment:**

Chandelier entirely made of porcelain. Made in different finishes to match all decorative ambiences. Not very heavy to simplify its installation. Bespoke measures available under request.

**Installation and assembly:**

Follow instructions of the installation guide

**Electrical characteristics:**

**Max. Power:** 12 x 18W  
**Tension:** CE-UK: 220/240VAC US-JP: 100/125VAC  
**Frequency:** 50/60Hz  
Dimmer not included / LED bulb non dimmable

**Recommended Bulb**

Bulb not included	Bulb reference
<b>CE:</b> 12 x G9 Led 3W 220V (190Lm)	01089407
<b>US:</b> 12 x G9 Led 3W 110V (190Lm)	

**Certificates:**

CE, SASO  
UL

**Physical characteristics:**

1 Box / 111 x 82 x 82 cm / 0,746 m3  
1 Box / 43 3/4 x 32 1/4 x 32 1/4 inches / 45503 in3  
Gross weight 36 Kg. / Net weight 8,3 Kg.

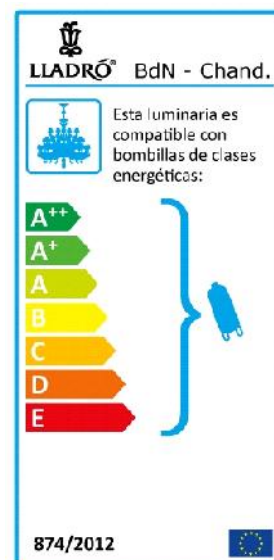

**Sketch**

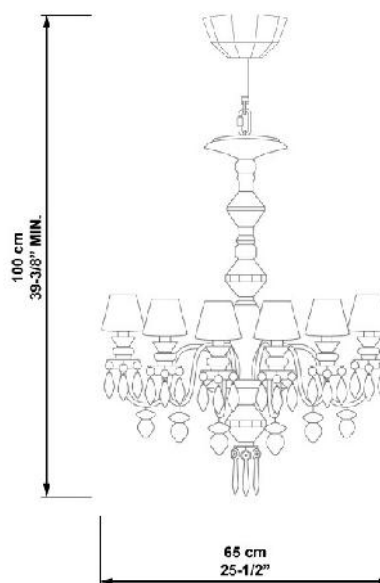

# Technical data sheet

<b>CE:</b>	Ref 01023311 - UPC/EAN 737859233111
<b>UK:</b>	Ref 01023311 - UPC/EAN 737859233111
<b>US:</b>	Ref 01023312 - UPC/EAN 737859233111
<b>JP:</b>	Ref 01023313 - UPC/EAN 737859233111

**Description:**

**Belle de Nuit - Chandelier 40 lights - gold**  
**Belle de Nuit - Chandelier 40 luces - oro**

**Collection:**

**BELLE DE NUIT**

**Mounting:**

Chandelier

**Environment:**

Chandelier entirely made of porcelain. Made in different finishes to match all decorative ambiances. Not very heavy to simplify its installation. Bespoke measures available under request.

**Installation and assembly:**

Follow instructions of the installation guide

**Electrical characteristics:**

**Max. Power:** 40 x 18W  
**Tension:** CE-UK: 220/240VAC US-JP: 100/125VAC  
**Frequency:** 50/60Hz  
Dimmer not included / LED bulb non dimmable

**Recommended Bulb**

Bulb not included	Bulb reference
<b>CE:</b> 40 x G9 Led 3W 220V (190Lm)	01089407
<b>US:</b> 40 x G9 Led 3W 110V (190Lm)	

**Certificates:**

CE, SASO  
UL

**Physical characteristics:**

1 Box / 140 x 119 x 119 cm / 1,983 m<sup>3</sup>  
1 Box / 55 x 46 3/4 x 46 3/4 inches / 120206 in<sup>3</sup>  
Gross weight 129,6 kg. / Net weight 27,4 kg.



**Sketch**

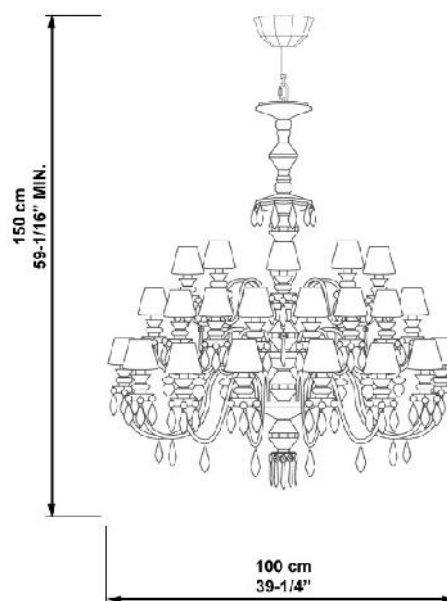

# Technical data sheet

**CE:** Ref 01023314 - UPC/EAN 737859233142  
**UK:** Ref 01023314 - UPC/EAN 737859233142  
**US:** Ref 01023315 - UPC/EAN 737859233142  
**JP:** Ref 01023316 - UPC/EAN 737859233142

**Description:**

**Belle de Nuit - Chandelier 24 lights - gold**  
**Belle de Nuit - Chandelier 24 luces - oro**

**Collection:**

**BELLE DE NUIT**

**Mounting:**

Chandelier

**Environment:**

Chandelier entirely made of porcelain. Made in different finishes to match all decorative ambiances. Not very heavy to simplify its installation. Bespoke measures available under request.

**Installation and assembly:**

Follow instructions of the installation guide

**Electrical characteristics:**

**Max. Power:** 24 x 18W  
**Tension:** CE-UK: 220/240VAC US-JP: 100/125VAC  
**Frequency:** 50/60Hz  
 Dimmer not included / LED bulb non dimmable

**Recommended Bulb**

Bulb not included	<b>Bulb reference</b>
<b>CE:</b> 24 x G9 Led 3W 220V (190Lm)	01089407
<b>US:</b> 24 x G9 Led 3W 110V (190Lm)	

**Certificates:**

CE, SASO  
UL

**Physical characteristics:**

1 Box / 135 x 105 x 105 cm / 1,488 m3  
 1 Box / 53 1/4 x 41 1/4 x 41 1/4 inches / 90608 in3  
 Gross weight 44,1 kg. / Net weight 21,2 kg.



**LLADRÓ** BdN - Chand.

Esta luminaria es compatible con bombillas de clases energéticas:

A++  
A+  
A  
B  
C  
D  
E

874/2012 

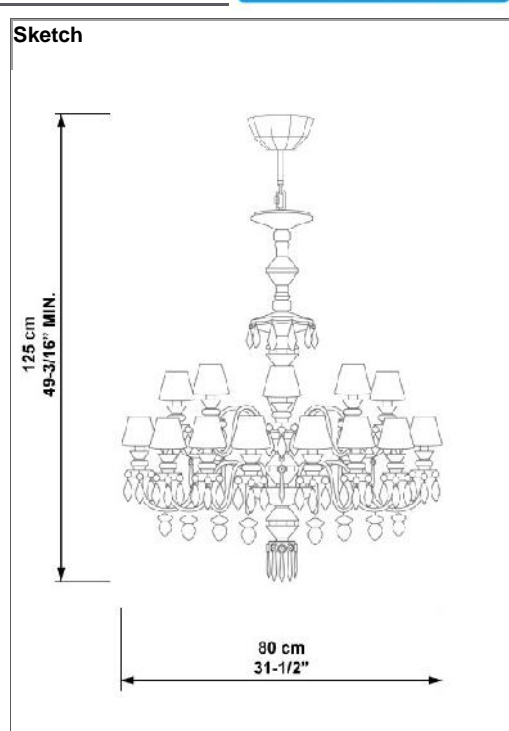

# Technical data sheet

**CE:** Ref 01023317 - UPC/EAN 737859233173  
**UK:** Ref 01023317 - UPC/EAN 737859233173  
**US:** Ref 01023318 - UPC/EAN 737859233173  
**JP:** Ref 01023319 - UPC/EAN 737859233173

**Description:**

**Belle de Nuit - Wall 2 lights - gold**  
**Belle de Nuit - Applique pared 2 luces - oro**

**Collection:**

**BELLE DE NUIT**

**Mounting:**

Wall light

**Environment:**

Wall lamp made of porcelain with decorative back mirror to enhance light effect. Made in different finishes to match all decorative ambiances. Easy to fit for a fast installation. Bespoke measures available under request.

**Installation and assembly:**

Follow instructions of the installation guide

**Electrical characteristics:**

**Max. Power:** 2 x 18W  
**Tension:** CE-UK: 220/240VAC US-JP: 100/125VAC  
**Frequency:** 50/60Hz  
 Dimmer not included / LED bulb non dimmable

**Recommended Bulb**

Bulb not included	<b>Bulb reference</b>
<b>CE:</b> 2 x G9 Led 3W 220V (190Lm)	1089407
<b>US:</b> 2 x G9 Led 3W 110V (190Lm)	

**Certificates:**

CE, SASO

**Physical characteristics:**

1 Box / 26,2 x 40,8 x 41,3 cm / 0,044 m3  
 1 Box / 10 1/4 x 16 x 16 1/4 inches / 2665 in3  
 Gross weight 3,1 kg. / Net weight 1,8 kg.

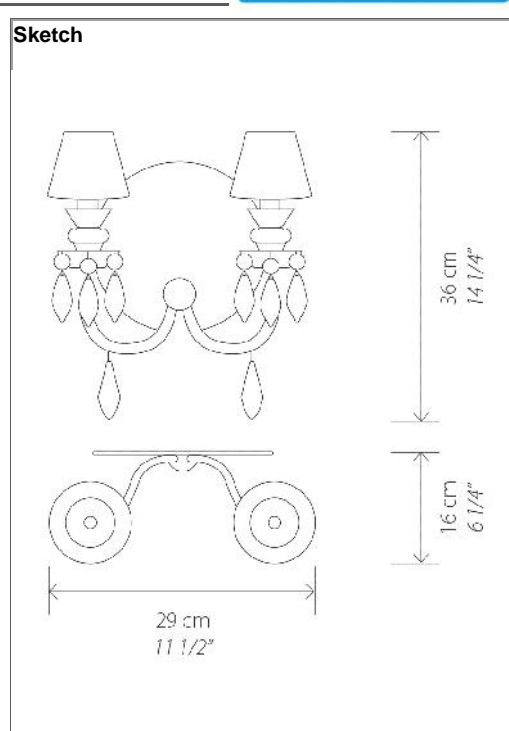

# Technical data sheet

**CE:** Ref 01023320 - UPC/EAN 737859233203  
**UK:** Ref 01023321 - UPC/EAN 737859233203  
**US:** Ref 01023322 - UPC/EAN 737859233203  
**JP:** Ref 01023323 - UPC/EAN 737859233203

**Description:**

**Belle de Nuit - Table Lamp - gold**  
**Belle de Nuit - Lámpara de sobremesa - oro**

**Collection:**

**BELLE DE NUIT**

**Mounting:**

Table lamp

**Environment:**

Table lamp body in porcelain. Available in different finishes to match all decorative ambiances

**Installation and assembly:**

Follow instructions of the installation guide

**Electrical characteristics:**

**Max. Power:** 1 x 18W  
**Tension:** CE-UK: 220/240VAC US-JP: 100/125VAC  
**Frequency:** 50/60Hz  
 Dimmer not included

**Recommended Bulb**

Bulb not included	<b>Bulb reference</b>
<b>CE:</b> 1 x E27 LED 6W (600 Lm)	01089432
<b>US:</b> 1 x E26 LED 6W (600 Lm)	

**Certificates:**

CE, SASO  
 UL

**Physical characteristics:**

1 Box / 49,7 x 32,3 x 56,8 cm / 0,091 m3  
 1 Box / 19 1/2 x 12 3/4 x 22 1/4 inches / 5532 in3  
 Gross weight 3,3 kg. / Net weight 1,3 kg.

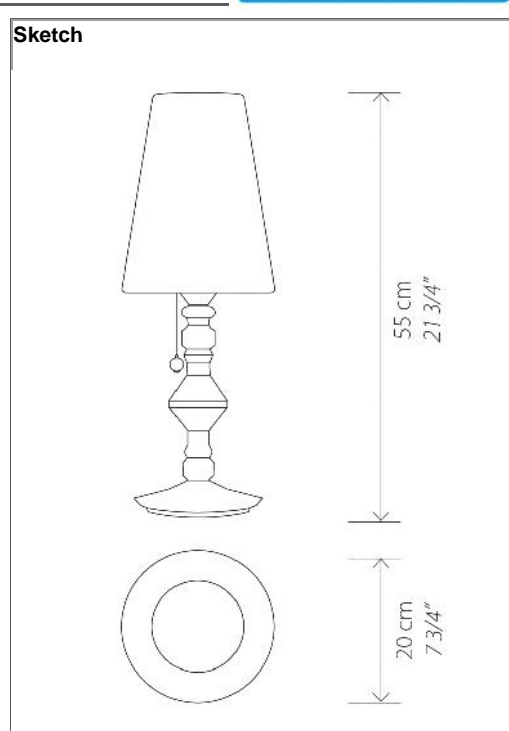

# Technical data sheet

<b>CE:</b>	Ref 01023324 - UPC/EAN 737859233241
<b>UK:</b>	Ref 01023325 - UPC/EAN 737859233241
<b>US:</b>	Ref 01023326 - UPC/EAN 737859233241
<b>JP:</b>	Ref 01023327 - UPC/EAN 737859233241

<b>Description:</b>	<b>Belle de Nuit - Lithophane Table Lamp - gold</b> <b>Belle de Nuit - Lámpara de mesa con Litofanía - oro</b>						
<b>Collection:</b>	<i>BELLE DE NUIT</i>						
<b>Mounting:</b>	Table lamp						
<b>Environment:</b>	Both lamp body and lampshade are made of porcelain. Available in different finishes to match all decorative ambiances.						
<b>Installation and assembly:</b>	Follow instructions of the installation guide						
<b>Electrical characteristics:</b>	<p><b>Max. Power:</b> 1 x 18W</p> <p><b>Tension:</b> CE-UK: 220/240VAC US-JP: 100/125VAC</p> <p><b>Frequency:</b> 50/60Hz</p> <p>Dimmer not included / LED bulb non dimmable</p>						
<b>Recommended Bulb</b>	<table border="0"> <thead> <tr> <th>Bulb not included</th> <th>Bulb reference</th> </tr> </thead> <tbody> <tr> <td><b>CE:</b> 1 x G9 Led 3W (máx: 20W)</td> <td>1089407</td> </tr> <tr> <td><b>US:</b> 1 x Edison E12 Incandescent 40W (m</td> <td></td> </tr> </tbody> </table>	Bulb not included	Bulb reference	<b>CE:</b> 1 x G9 Led 3W (máx: 20W)	1089407	<b>US:</b> 1 x Edison E12 Incandescent 40W (m	
Bulb not included	Bulb reference						
<b>CE:</b> 1 x G9 Led 3W (máx: 20W)	1089407						
<b>US:</b> 1 x Edison E12 Incandescent 40W (m							
<b>Certificates:</b>	CE. SASO UL certification						
<b>Physical characteristics:</b>	<p>1 Box / 17,9 x 24,9 x 42,3 cm / 0,019 m3</p> <p>1 Box / 7 x 9 3/4 x 16 3/4 inches / 1143 in3</p> <p>Gross weight 1,4 kg. / Net weight 0,7 kg.</p>						



Sketch

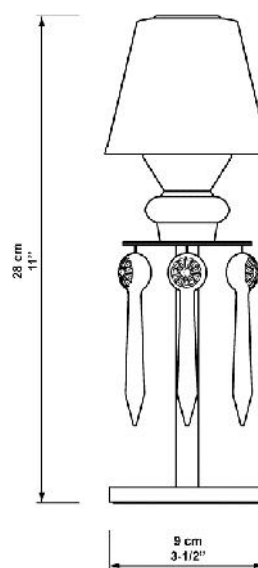

# Technical data sheet

<b>CE:</b>	Ref 01023363 - UPC/EAN 737859233630
<b>UK:</b>	Ref 01023363 - UPC/EAN 737859233630
<b>US:</b>	Ref 01023364 - UPC/EAN 737859233630
<b>JP:</b>	Ref 01023365 - UPC/EAN 737859233630

## Description:

**Belle de Nuit - pendant lamp I - white**  
**Belle de Nuit - Lámpara de techo I - blanco**

## Collection:

**BELLE DE NUIT**

## Mounting:

Pendant

## Environment:

Hanging lamp body made of porcelain. Available in different finishes to match all decorative ambiances. Easy to fix to ceiling system and capable of changing length during installation. This model fits well on a corner display but also on reception desks.

## Installation and assembly:

Follow instructions of the installation guide

## Electrical characteristics:

**Max. Power:** 1 x 18W  
**Tension:** CE-UK: 220/240VAC US-JP: 100/125VAC  
**Frequency:** 50/60Hz  
Dimmer not included

## Recommended Bulb

Bulb not included	Bulb reference
<b>CE:</b> 1 x E27 LED 6W (600 Lm)	01089432
<b>US:</b> 1 x E26 LED 6W (600 Lm)	

## Certificates:

CE, SASO  
UL

## Physical characteristics:

1 Box / 9,153 x 100 x 100 cm / 0,092 m3  
1 Box / 3 1/2 x 39 1/4 x 39 1/4 inches / 5392 in3  
Gross weight 3,3 Kg. / Net weight 1,2 Kg.

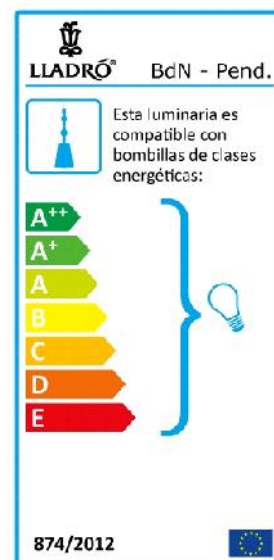

## Sketch

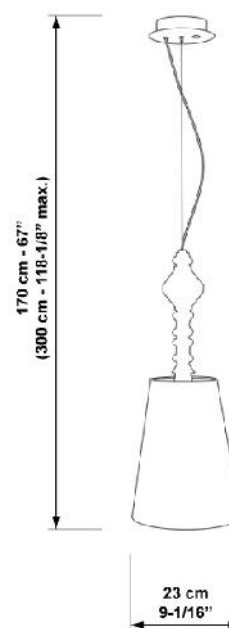

# Technical data sheet

**CE:** Ref 01023366 - UPC/EAN 737859233661  
**UK:** Ref 01023366 - UPC/EAN 737859233661  
**US:** Ref 01023367 - UPC/EAN 737859233661  
**JP:** Ref 01023368 - UPC/EAN 737859233661

**Description:**

**Belle de Nuit - pendant lamp II - white**  
**Belle de Nuit - Lámpara de techo II - blanco**

**Collection:**

*BELLE DE NUIT*

**Mounting:**

Pendant

**Environment:**

Hanging lamp body made of porcelain. Available in different finishes to match all decorative ambiances. Easy to fix to ceiling system and capable of changing length during installation. This model fits well on a corner display but also on reception desks.

**Installation and assembly:**

Follow instructions of the installation guide

**Electrical characteristics:**

**Max. Power:** 1 x 18W  
**Tension:** CE-UK: 220/240VAC US-JP: 100/125VAC  
**Frequency:** 50/60Hz  
 Dimmer not included

**Recommended Bulb**

Bulb not included	<b>Bulb reference</b>
<b>CE:</b> 1 x E27 LED 6W (600 Lm)	01089432
<b>US:</b> 1 x E26 LED 6W (600 Lm)	

**Certificates:**

CE, SASO  
UL

**Physical characteristics:**

1 Box / 10,694 x 100 x 100 cm / 0,107 m3  
 1 Box / 4 1/4 x 39 1/4 x 39 1/4 inches / 6547 in3  
 Gross weight 4,1 Kg. / Net weight 1,8 Kg.

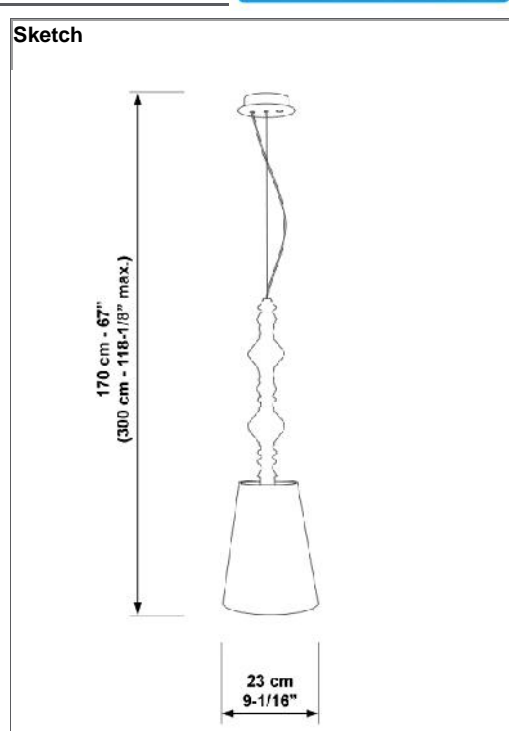
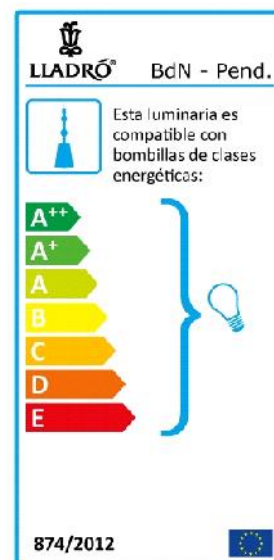

# Technical data sheet

**CE:** Ref 01023369 - UPC/EAN 737859233692  
**UK:** Ref 01023370 - UPC/EAN 737859233692  
**US:** Ref 01023371 - UPC/EAN 737859233692  
**JP:** Ref 01023372 - UPC/EAN 737859233692

**Description:**

**Belle de Nuit - Floor Lamp I - white**  
**Belle de Nuit - Lámpara de pie I - blanco**

**Collection:**

**BELLE DE NUIT**

**Mounting:**

Floor lamp

**Environment:**

Standing lamp body made of porcelain. Available in different finishes to match all decorative ambiances. This model fits well alone or in combination with other items from the same collection

**Installation and assembly:**

Follow instructions of the installation guide

**Electrical characteristics:**

**Max. Power:** 1 x 18W  
**Tension:** CE-UK: 220/240VAC US-JP: 100/125VAC  
**Frequency:** 50/60Hz

**Recommended Bulb**

Bulb not included **Bulb reference**  
**CE:** 1 x E27 LED 6W (600 Lm)  
**US:** 1 x E26 LED 6W (600 Lm)

**Certificates:**

CE, SASO  
 UL

**Physical characteristics:**

1 Box / 35 x 33 x 193 cm / 0,223 m3  
 1 Box / 13 3/4 x 13 x 76 inches / 13585 in3  
 Gross weight 7,7 Kg. / Net weight 3,9 Kg.



**Sketch**

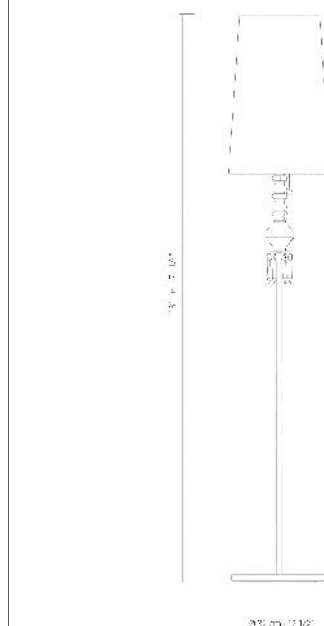

# Technical data sheet

**CE:** Ref 01023373 - UPC/EAN 737859233739  
**UK:** Ref 01023374 - UPC/EAN 737859233739  
**US:** Ref 01023375 - UPC/EAN 737859233739  
**JP:** Ref 01023376 - UPC/EAN 737859233739

**Description:**

**Belle de Nuit - Floor Lamp II - white**  
**Belle de Nuit - Lámpara de pie II - blanco**

**Collection:**

**BELLE DE NUIT**

**Mounting:**

Floor lamp

**Environment:**

Standing lamp body made of porcelain. Available in different finishes to match all decorative ambiances. This model fits well alone or in combination with other items from the same collection

**Installation and assembly:**

Follow instructions of the installation guide

**Electrical characteristics:**

**Max. Power:** 1 x 18W  
**Tension:** CE-UK: 220/240VAC US-JP: 100/125VAC  
**Frequency:** 50/60Hz

**Recommended Bulb**

Bulb not included **Bulb reference**  
**CE:** 1 x E27 LED 6W (600 Lm)  
**US:** 1 x E26 LED 6W (600 Lm)

**Certificates:**

CE, SASO  
 UL

**Physical characteristics:**

1 Box / 35 x 33 x 193 cm / 0,223 m3  
 1 Box / 13 3/4 x 13 x 76 inches / 13585 in3  
 Gross weight 8,6 Kg. / Net weight 4,2 Kg.



**Sketch**

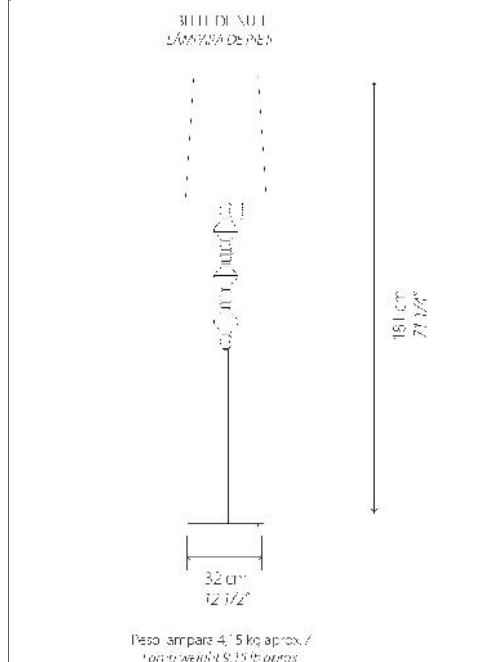

# Technical data sheet

**CE:** Ref 01023380 - UPC/EAN 737859233807  
**UK:** Ref 01023380 - UPC/EAN 737859233807  
**US:** Ref 01023381 - UPC/EAN 737859233807  
**JP:** Ref 01023382 - UPC/EAN 737859233807

**Description:**

**Belle de Nuit - pendant lamp I - black**  
**Belle de Nuit - Lámpara de techo I - negro**

**Collection:**

*BELLE DE NUIT*

**Mounting:**

Pendant

**Environment:**

Hanging lamp body made of porcelain. Available in different finishes to match all decorative ambiances. Easy to fix to ceiling system and capable of changing length during installation. This model fits well on a corner display but also on reception desks.

**Installation and assembly:**

Follow instructions of the installation guide

**Electrical characteristics:**

**Max. Power:** 1 x 18W  
**Tension:** CE-UK: 220/240VAC US-JP: 100/125VAC  
**Frequency:** 50/60Hz  
 Dimmer not included

**Recommended Bulb**

Bulb not included	<b>Bulb reference</b>
<b>CE:</b> 1 x E27 LED 6W (600 Lm)	01089432
<b>US:</b> 1 x E26 LED 6W (600 Lm)	

**Certificates:**

CE, SASO  
UL

**Physical characteristics:**

1 Box / 9,153 x 100 x 100 cm / 0,092 m3  
 1 Box / 3 1/2 x 39 1/4 x 39 1/4 inches / 5392 in3  
 Gross weight 3,3 Kg. / Net weight 1,2 Kg.

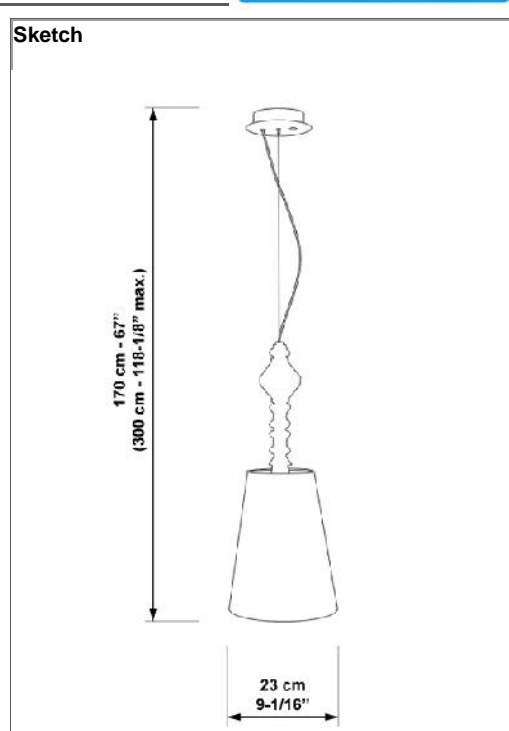
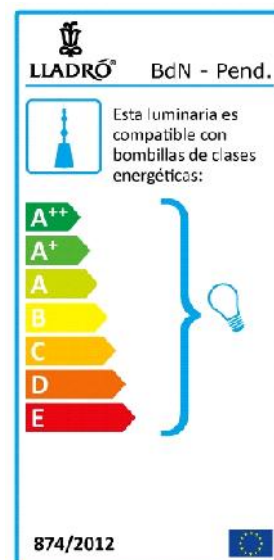

# Technical data sheet

<b>CE:</b>	Ref 01023383 - UPC/EAN 737859233838
<b>UK:</b>	Ref 01023383 - UPC/EAN 737859233838
<b>US:</b>	Ref 01023384 - UPC/EAN 737859233838
<b>JP:</b>	Ref 01023385 - UPC/EAN 737859233838

**Description:**

**Belle de Nuit - pendant lamp II - black**  
**Belle de Nuit - Lámpara de techo II - negro**

**Collection:**

**BELLE DE NUIT**

**Mounting:**

Pendant

**Environment:**

Hanging lamp body made of porcelain. Available in different finishes to match all decorative ambiances. Easy to fix to ceiling system and capable of changing length during installation. This model fits well on a corner display but also on reception desks.

**Installation and assembly:**

Follow instructions of the installation guide

**Electrical characteristics:**

**Max. Power:** 1 x 18W  
**Tension:** CE-UK: 220/240VAC US-JP: 100/125VAC  
**Frequency:** 50/60Hz  
Dimmer not included

**Recommended Bulb**

Bulb not included	Bulb reference
<b>CE:</b> 1 x E27 LED 6W (600 Lm)	01089432
<b>US:</b> 1 x E26 LED 6W (600 Lm)	

**Certificates:**

CE, SASO, CCC  
UL

**Physical characteristics:**

1 Box / 10,694 x 100 x 100 cm / 0,107 m3  
1 Box / 4 1/4 x 39 1/4 x 39 1/4 inches / 6547 in3  
Gross weight 4,1 Kg. / Net weight 1,8 Kg.

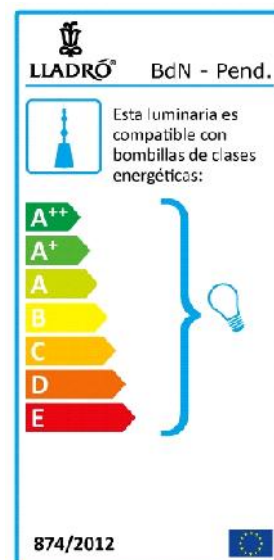

**Sketch**

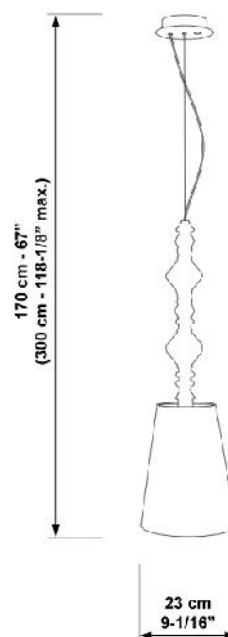



# Technical data sheet

**CE:** Ref 01023386 - UPC/EAN 737859233869  
**UK:** Ref 01023387 - UPC/EAN 737859233869  
**US:** Ref 01023388 - UPC/EAN 737859233869  
**JP:** Ref 01023389 - UPC/EAN 737859233869

**Description:**

**Belle de Nuit - Floor Lamp I - black**  
**Belle de Nuit - Lámpara de pie I - negro**

**Collection:**

*BELLE DE NUIT*

**Mounting:**

Floor lamp

**Environment:**

Standing lamp body made of porcelain. Available in different finishes to match all decorative ambiances. This model fits well alone or in combination with other items from the same collection

**Installation and assembly:**

Follow instructions of the installation guide

**Electrical characteristics:**

**Max. Power:** 1 x 18W  
**Tension:** CE-UK: 220/240VAC US-JP: 100/125VAC  
**Frequency:** 50/60Hz

**Recommended Bulb**

Bulb not included **Bulb reference**  
**CE:** 1 x E27 LED 6W (600 Lm)  
**US:** 1 x E26 LED 6W (600 Lm)

**Certificates:**

CE, SASO  
 UL

**Physical characteristics:**

1 Box / 35 x 33 x 193 cm / 0,223 m3  
 1 Box / 13 3/4 x 13 x 76 inches / 13585 in3  
 Gross weight 7,7 Kg. / Net weight 3,9 Kg.



**Sketch**

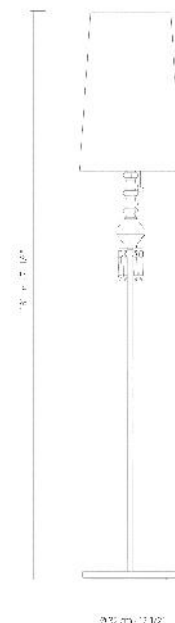

# Technical data sheet

<b>CE:</b>	Ref 01023390 - UPC/EAN 737859233906
<b>UK:</b>	Ref 01023391 - UPC/EAN 737859233906
<b>US:</b>	Ref 01023392 - UPC/EAN 737859233906
<b>JP:</b>	Ref 01023393 - UPC/EAN 737859233906

**Description:**

**Belle de Nuit - Floor Lamp II - black**  
**Belle de Nuit - Lámpara de pie II - negro**

**Collection:**

**BELLE DE NUIT**

**Mounting:**

Floor lamp

**Environment:**

Standing lamp body made of porcelain. Available in different finishes to match all decorative ambiances. This model fits well alone or in combination with other items from the same collection

**Installation and assembly:**

Follow instructions of the installation guide

**Electrical characteristics:**

**Max. Power:** 1 x 18W  
**Tension:** CE-UK: 220/240VAC US-JP: 100/125VAC  
**Frequency:** 50/60Hz

**Recommended Bulb**

Bulb not included **Bulb reference**  
**CE:** 1 x E27 LED 6W (600 Lm)  
**US:** 1 x E26 LED 6W (600 Lm)

**Certificates:**

CE, SASO  
UL

**Physical characteristics:**

1 Box / 35 x 33 x 193 cm / 0,223 m3  
1 Box / 13 3/4 x 13 x 76 inches / 13585 in3  
Gross weight 8,6 Kg. / Net weight 4,2 Kg.



**Sketch**

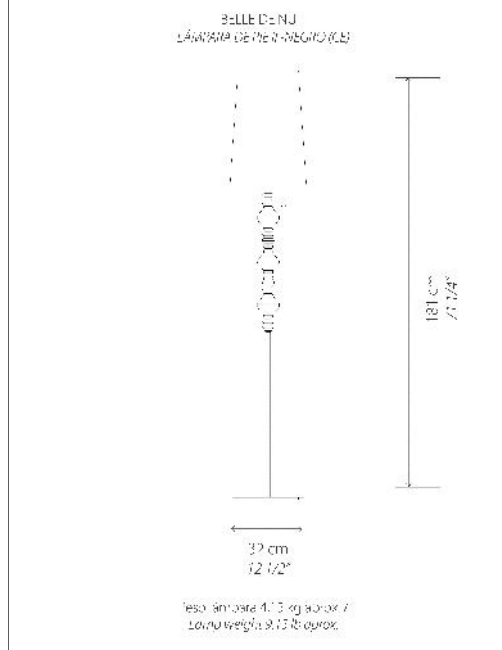

# Technical data sheet

**CE:** Ref 01023394 - UPC/EAN 737859233944  
**UK:** Ref 01023394 - UPC/EAN 737859233944  
**US:** Ref 01023395 - UPC/EAN 737859233944  
**JP:** Ref 01023396 - UPC/EAN 737859233944

**Description:**

**Belle de Nuit - lithophane hanging lamp - black**  
**Belle de Nuit - Lámpara litofanía colgante - negro**

**Collection:**

*BELLE DE NUIT*

**Mounting:**

Pendant

**Environment:**

Both hanging lamp body and lampshade are made of porcelain. Available in different finishes to match all decorative ambiances. Easy to fix to ceiling system and capable of changing length during installation. This model fits well on a corner display

**Installation and assembly:**

Follow instructions of the installation guide

**Electrical characteristics:**

**Max. Power:** 1 x 18W  
**Tension:** CE-UK: 220/240VAC US-JP: 100/125VAC  
**Frequency:** 50/60Hz

**Recommended Bulb**

Bulb not included	Bulb reference
<b>CE:</b> 1 x G9 LED 3W 220V (190Lm)	01089407
<b>US:</b> 1 x G9 LED 3W 110V (190Lm)	

**Certificates:**

CE, SASO

**Physical characteristics:**

1 Box / 17,9 x 24,9 x 42,3 cm / 0,019 m3  
 1 Box / 7 x 9 3/4 x 16 3/4 inches / 1143 in3  
 Gross weight 1,7 Kg. / Net weight 0,8 Kg.



**Sketch**

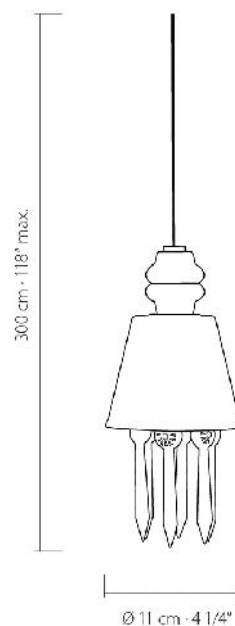

# Technical data sheet

**CE:** Ref 01023397 - UPC/EAN 737859233975  
**UK:** Ref 01023397 - UPC/EAN 737859233975  
**US:** Ref 01023398 - UPC/EAN 737859233975  
**JP:** Ref 01023399 - UPC/EAN 737859233975

**Description:**

**Belle de Nuit - pendant lamp I - blue**  
**Belle de Nuit - Lámpara de techo I - azul**

**Collection:**

*BELLE DE NUIT*

**Mounting:**

Pendant

**Environment:**

Hanging lamp body made of porcelain. Available in different finishes to match all decorative ambiances. Easy to fix to ceiling system and capable of changing length during installation. This model fits well on a corner display but also on reception desks.

**Installation and assembly:**

Follow instructions of the installation guide

**Electrical characteristics:**

**Max. Power:** 1 x 18W  
**Tension:** CE-UK: 220/240VAC US-JP: 100/125VAC  
**Frequency:** 50/60Hz  
 Dimmer not included

**Recommended Bulb**

Bulb not included	<b>Bulb reference</b>
<b>CE:</b> 1 x E27 LED 6W (600 Lm)	01089432
<b>US:</b> 1 x E26 LED 6W (600 Lm)	

**Certificates:**

CE, SASO  
UL

**Physical characteristics:**

1 Box / 9,153 x 100 x 100 cm / 0,092 m3  
 1 Box / 3 1/2 x 39 1/4 x 39 1/4 inches / 5392 in3  
 Gross weight 3,3 Kg. / Net weight 1,2 Kg.

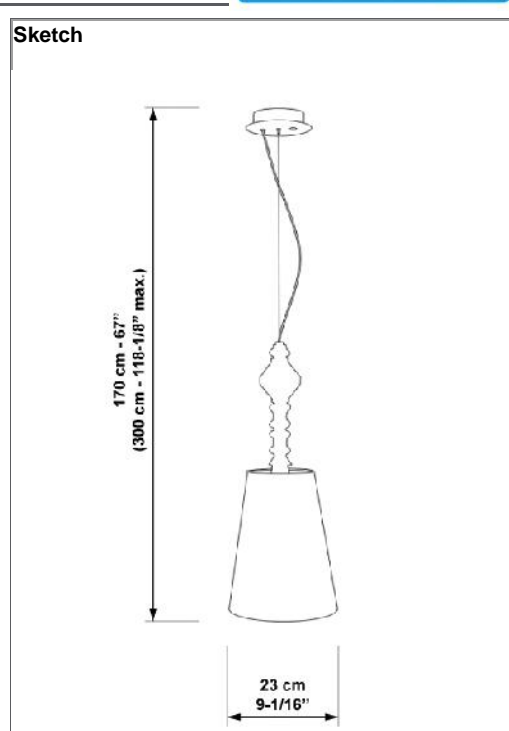
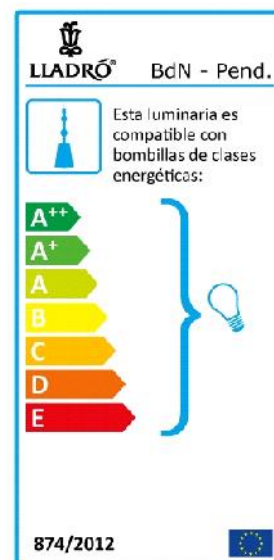

# Technical data sheet

**CE:** Ref 01023400 - UPC/EAN 737859234002  
**UK:** Ref 01023400 - UPC/EAN 737859234002  
**US:** Ref 01023401 - UPC/EAN 737859234002  
**JP:** Ref 01023402 - UPC/EAN 737859234002

**Description:**

**Belle de Nuit - pendant lamp II - blue**  
**Belle de Nuit - Lámpara de techo II - azul**

**Collection:**

**BELLE DE NUIT**

**Mounting:**

Pendant

**Environment:**

Hanging lamp body made of porcelain. Available in different finishes to match all decorative ambiances. Easy to fix to ceiling system and capable of changing length during installation. This model fits well on a corner display but also on reception desks.

**Installation and assembly:**

Follow instructions of the installation guide

**Electrical characteristics:**

**Max. Power:** 1 x 18W  
**Tension:** CE-UK: 220/240VAC US-JP: 100/125VAC  
**Frequency:** 50/60Hz  
 Dimmer not included

**Recommended Bulb**

Bulb not included	<b>Bulb reference</b>
<b>CE:</b> 1 x E27 LED 6W (600 Lm)	01089432
<b>US:</b> 1 x E26 LED 6W (600 Lm)	

**Certificates:**

CE, SASO  
UL

**Physical characteristics:**

1 Box / 10,694 x 100 x 100 cm / 0,107 m3  
 1 Box / 4 1/4 x 39 1/4 x 39 1/4 inches / 6547 in3  
 Gross weight 4,1 Kg. / Net weight 1,8 Kg.

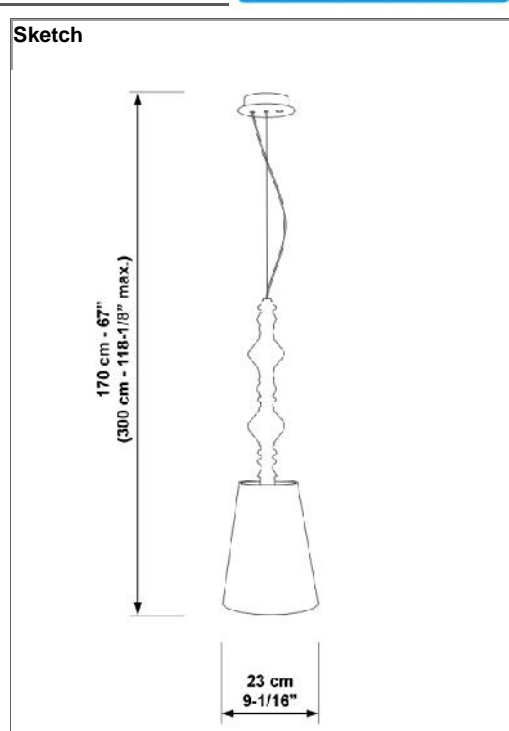
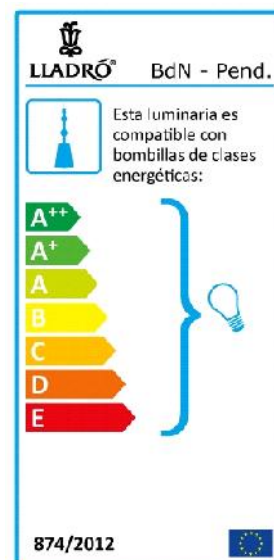

# Technical data sheet

**CE:** Ref 01023403 - UPC/EAN 737859234033  
**UK:** Ref 01023404 - UPC/EAN 737859234033  
**US:** Ref 01023405 - UPC/EAN 737859234033  
**JP:** Ref 01023406 - UPC/EAN 737859234033

<b>Description:</b>	<b>Belle de Nuit - Floor Lamp I - blue</b> <b>Belle de Nuit - Lámpara de pie I - azul</b>
<b>Collection:</b>	<b>BELLE DE NUIT</b>
<b>Mounting:</b>	Floor lamp
<b>Environment:</b>	Standing lamp body made of porcelain. Available in different finishes to match all decorative ambiances. This model fits well alone or in combination with other items from the same collection
<b>Installation and assembly:</b>	Follow instructions of the installation guide
<b>Electrical characteristics:</b>	<b>Max. Power:</b> 1 x 18W <b>Tension:</b> CE-UK: 220/240VAC US-JP: 100/125VAC <b>Frequency:</b> 50/60Hz
<b>Recommended Bulb</b>	<b>Bulb not included</b> <span style="float: right;"><b>Bulb reference</b></span> <b>CE:</b> 1 x E27 LED 6W (600 Lm) <b>US:</b> 1 x E26 LED 6W (600 Lm)
<b>Certificates:</b>	CE, SASO UL
<b>Physical characteristics:</b>	1 Box / 35 x 33 x 193 cm / 0,223 m3 1 Box / 13 3/4 x 13 x 76 inches / 13585 in3 Gross weight 7,7 Kg. / Net weight 3,9 Kg.



Sketch

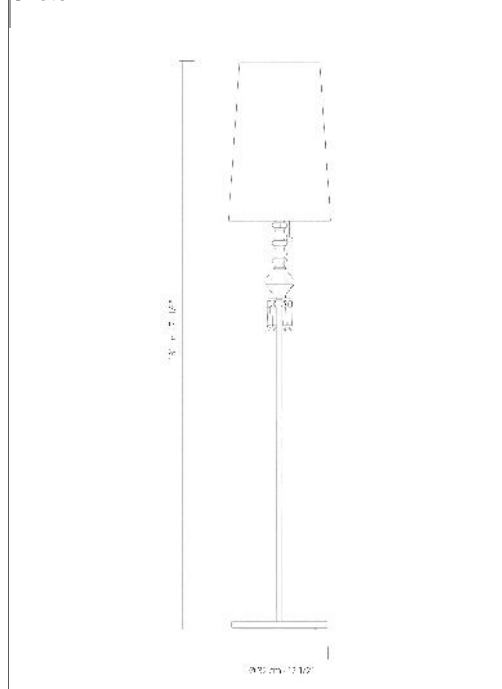

# Technical data sheet

**CE:** Ref 01023407 - UPC/EAN 737859234071  
**UK:** Ref 01023408 - UPC/EAN 737859234071  
**US:** Ref 01023409 - UPC/EAN 737859234071  
**JP:** Ref 01023410 - UPC/EAN 737859234071

**Description:**

**Belle de Nuit - Floor Lamp II - blue**  
**Belle de Nuit - Lámpara de pie II - azul**

**Collection:**

***BELLE DE NUIT***

**Mounting:**

Floor lamp

**Environment:**

Standing lamp body made of porcelain. Available in different finishes to match all decorative ambiances. This model fits well alone or in combination with other items from the same collection

**Installation and assembly:**

Follow instructions of the installation guide

**Electrical characteristics:**

**Max. Power:** 1 x 18W  
**Tension:** CE-UK: 220/240VAC US-JP: 100/125VAC  
**Frequency:** 50/60Hz

**Recommended Bulb**

Bulb not included **Bulb reference**  
**CE:** 1 x E27 LED 6W (600 Lm)  
**US:** 1 x E26 LED 6W (600 Lm)

**Certificates:**

CE, SASO  
 UL

**Physical characteristics:**

1 Box / 35 x 33 x 193 cm / 0,223 m3  
 1 Box / 13 3/4 x 13 x 76 inches / 13585 in3  
 Gross weight 8,6 Kg. / Net weight 4,2 Kg.



**Sketch**

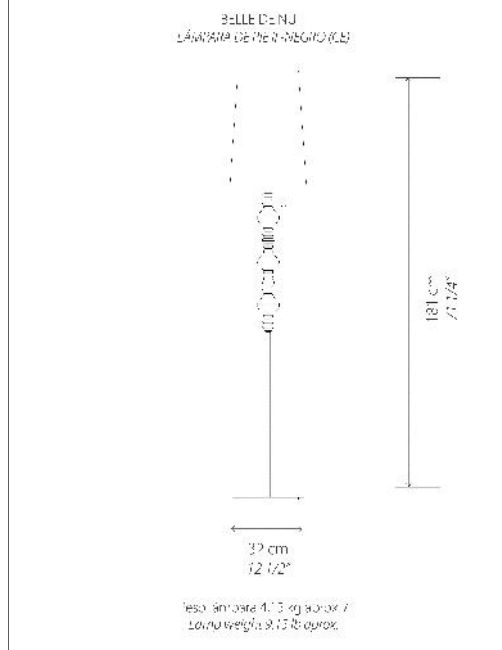

# Technical data sheet

**CE:** Ref 01023411 - UPC/EAN 737859234118  
**UK:** Ref 01023411 - UPC/EAN 737859234118  
**US:** Ref 01023412 - UPC/EAN 737859234118  
**JP:** Ref 01023413 - UPC/EAN 737859234118

**Description:**

**Belle de Nuit - lithophane hanging lamp - blue**  
**Belle de Nuit - Lámpara litofanía colgante - azul**

**Collection:**

*BELLE DE NUIT*

**Mounting:**

Pendant

**Environment:**

Both hanging lamp body and lampshade are made of porcelain. Available in different finishes to match all decorative ambiances. Easy to fix to ceiling system and capable of changing length during installation. This model fits well on a corner display

**Installation and assembly:**

Follow instructions of the installation guide

**Electrical characteristics:**

**Max. Power:** 1 x 18W  
**Tension:** CE-UK: 220/240VAC US-JP: 100/125VAC  
**Frequency:** 50/60Hz

**Recommended Bulb**

Bulb not included	Bulb reference
<b>CE:</b> 1 x G9 LED 3W 220V (190Lm)	01089407
<b>US:</b> 1 x G9 LED 3W 110V (190Lm)	

**Certificates:**

CE, SASO

**Physical characteristics:**

1 Box / 17,9 x 24,9 x 42,3 cm / 0,019 m3  
 1 Box / 7 x 9 3/4 x 16 3/4 inches / 1143 in3  
 Gross weight 1,7 Kg. / Net weight 0,8 Kg.



**Sketch**

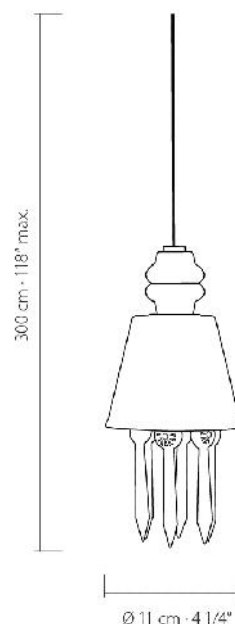



# Technical data sheet

**CE:** Ref 01023414 - UPC/EAN 737859234149  
**UK:** Ref 01023414 - UPC/EAN 737859234149  
**US:** Ref 01023415 - UPC/EAN 737859234149  
**JP:** Ref 01023416 - UPC/EAN 737859234149

**Description:**

**Belle de Nuit - pendant lamp I - pink**  
**Belle de Nuit - Lámpara de techo I - rosa**

**Collection:**

**BELLE DE NUIT**

**Mounting:**

Pendant

**Environment:**

Hanging lamp body made of porcelain. Available in different finishes to match all decorative ambiances. Easy to fix to ceiling system and capable of changing length during installation. This model fits well on a corner display but also on reception desks.

**Installation and assembly:**

Follow instructions of the installation guide

**Electrical characteristics:**

**Max. Power:** 1 x 18W  
**Tension:** CE-UK: 220/240VAC US-JP: 100/125VAC  
**Frequency:** 50/60Hz  
 Dimmer not included

**Recommended Bulb**

Bulb not included	<b>Bulb reference</b>
<b>CE:</b> 1 x E27 LED 6W (600 Lm)	01089432
<b>US:</b> 1 x E26 LED 6W (600 Lm)	

**Certificates:**

CE, SASO  
 UL

**Physical characteristics:**

1 Box / 9,153 x 100 x 100 cm / 0,092 m3  
 1 Box / 3 1/2 x 39 1/4 x 39 1/4 inches / 5392 in3  
 Gross weight 3,3 Kg. / Net weight 1,2 Kg.

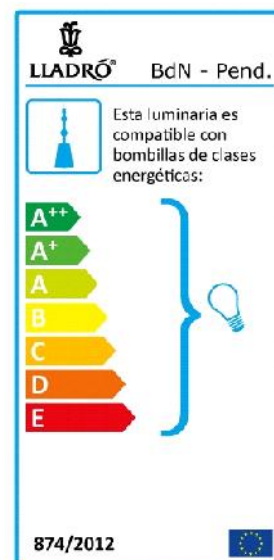

**Sketch**

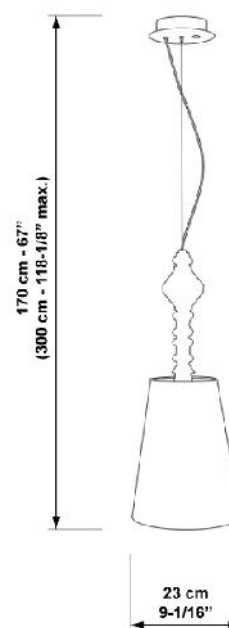

# Technical data sheet

**CE:** Ref 01023417 - UPC/EAN 737859234170  
**UK:** Ref 01023417 - UPC/EAN 737859234170  
**US:** Ref 01023418 - UPC/EAN 737859234170  
**JP:** Ref 01023419 - UPC/EAN 737859234170

**Description:**

**Belle de Nuit - pendant lamp II - pink**  
**Belle de Nuit - Lámpara de techo II - rosa**

**Collection:**

**BELLE DE NUIT**

**Mounting:**

Pendant

**Environment:**

Hanging lamp body made of porcelain. Available in different finishes to match all decorative ambiances. Easy to fix to ceiling system and capable of changing length during installation. This model fits well on a corner display but also on reception desks.

**Installation and assembly:**

Follow instructions of the installation guide

**Electrical characteristics:**

**Max. Power:** 1 x 18W  
**Tension:** CE-UK: 220/240VAC US-JP: 100/125VAC  
**Frequency:** 50/60Hz

**Recommended Bulb**

Bulb not included	<b>Bulb reference</b>
<b>CE:</b> 1 x E27 LED 6W (600 Lm)	01089432
<b>US:</b> 1 x E26 LED 6W (600 Lm)	

**Certificates:**

CE, SASO, CCC  
 UL

**Physical characteristics:**

1 Box / 10,694 x 100 x 100 cm / 0,107 m3  
 1 Box / 4 1/4 x 39 1/4 x 39 1/4 inches / 6547 in3  
 Gross weight 4,1 Kg. / Net weight 1,8 Kg.

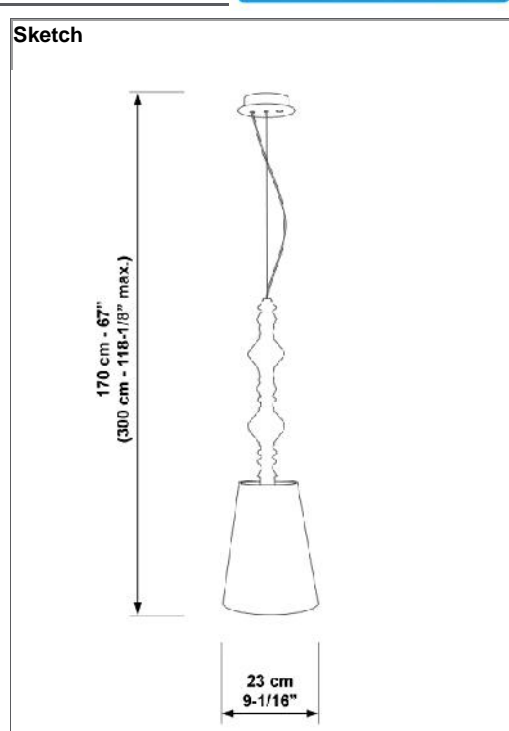
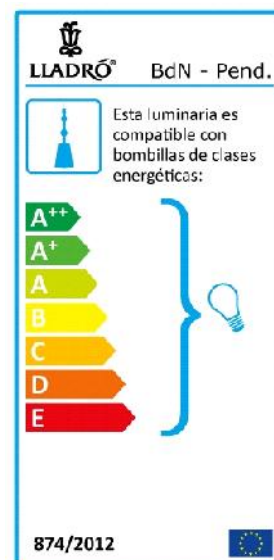

# Technical data sheet

**CE:** Ref 01023420 - UPC/EAN 737859234200  
**UK:** Ref 01023421 - UPC/EAN 737859234200  
**US:** Ref 01023422 - UPC/EAN 737859234200  
**JP:** Ref 01023423 - UPC/EAN 737859234200

**Description:**

**Belle de Nuit - Floor Lamp I - pink**  
**Belle de Nuit - Lámpara de pie I - rosa**

**Collection:**

**BELLE DE NUIT**

**Mounting:**

Floor lamp

**Environment:**

Standing lamp body made of porcelain. Available in different finishes to match all decorative ambiances. This model fits well alone or in combination with other items from the same collection

**Installation and assembly:**

Follow instructions of the installation guide

**Electrical characteristics:**

**Max. Power:** 1 x 18W  
**Tension:** CE-UK: 220/240VAC US-JP: 100/125VAC  
**Frequency:** 50/60Hz

**Recommended Bulb**

Bulb not included **Bulb reference**  
**CE:** 1 x E27 LED 6W (600 Lm)  
**US:** 1 x E26 LED 6W (600 Lm)

**Certificates:**

CE, SASO  
 UL

**Physical characteristics:**

1 Box / 35 x 33 x 193 cm / 0,223 m3  
 1 Box / 13 3/4 x 13 x 76 inches / 13585 in3  
 Gross weight 7,7 Kg. / Net weight 3,9 Kg.



**Sketch**

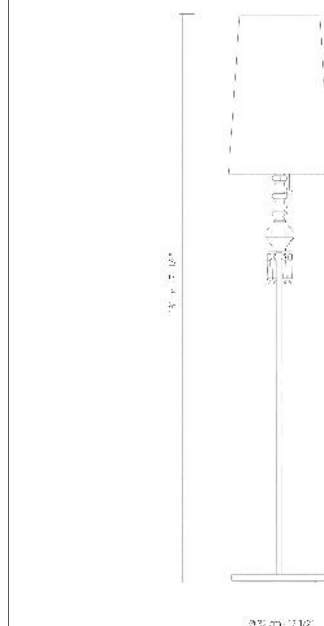

# Technical data sheet

**CE:** Ref 01023424 - UPC/EAN 737859234248  
**UK:** Ref 01023425 - UPC/EAN 737859234248  
**US:** Ref 01023426 - UPC/EAN 737859234248  
**JP:** Ref 01023427 - UPC/EAN 737859234248

**Description:**

**Belle de Nuit - Floor Lamp II - pink**  
**Belle de Nuit - Lámpara de pie II - rosa**

**Collection:**

**BELLE DE NUIT**

**Mounting:**

Floor lamp

**Environment:**

Standing lamp body made of porcelain. Available in different finishes to match all decorative ambiances. This model fits well alone or in combination with other items from the same collection

**Installation and assembly:**

Follow instructions of the installation guide

**Electrical characteristics:**

**Max. Power:** 1 x 18W  
**Tension:** CE-UK: 220/240VAC US-JP: 100/125VAC  
**Frequency:** 50/60Hz

**Recommended Bulb**

Bulb not included **Bulb reference**  
**CE:** 1 x E27 LED 6W (600 Lm)  
**US:** 1 x E26 LED 6W (600 Lm)

**Certificates:**

CE, SASO  
 UL

**Physical characteristics:**

1 Box / 35 x 33 x 193 cm / 0,223 m3  
 1 Box / 13 3/4 x 13 x 76 inches / 13585 in3  
 Gross weight 8,6 Kg. / Net weight 4,2 Kg.



**Sketch**

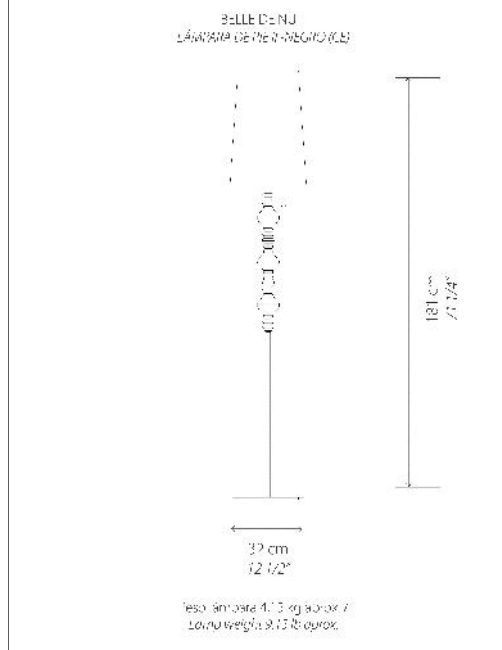

# Technical data sheet

<b>CE:</b>	Ref 01023428 - UPC/EAN 737859234286
<b>UK:</b>	Ref 01023428 - UPC/EAN 737859234286
<b>US:</b>	Ref 01023429 - UPC/EAN 737859234286
<b>JP:</b>	Ref 01023430 - UPC/EAN 737859234286

<b>Description:</b>	<b>Belle de Nuit - lithophane hanging lamp - pink</b> <b>Belle de Nuit - Lámpara litofanía colgante - rosa</b>						
<b>Collection:</b>	<b>BELLE DE NUIT</b>						
<b>Mounting:</b>	Pendant						
<b>Environment:</b>	Both hanging lamp body and lampshade are made of porcelain. Available in different finishes to match all decorative ambiances. Easy to fix to ceiling system and capable of changing length during installation. This model fits well on a corner display						
<b>Installation and assembly:</b>	Follow instructions of the installation guide						
<b>Electrical characteristics:</b>	<p><b>Max. Power:</b> 1 x 18W</p> <p><b>Tension:</b> CE-UK: 220/240VAC US-JP: 100/125VAC</p> <p><b>Frequency:</b> 50/60Hz</p> <p>Dimmer not included</p>						
<b>Recommended Bulb</b>	<table border="0"> <tr> <td>Bulb not included</td> <td><b>Bulb reference</b></td> </tr> <tr> <td><b>CE:</b> 1 x G9 LED 3W 220V (190Lm)</td> <td>01089407</td> </tr> <tr> <td><b>US:</b> 1 x G9 LED 3W 110V (190Lm)</td> <td></td> </tr> </table>	Bulb not included	<b>Bulb reference</b>	<b>CE:</b> 1 x G9 LED 3W 220V (190Lm)	01089407	<b>US:</b> 1 x G9 LED 3W 110V (190Lm)	
Bulb not included	<b>Bulb reference</b>						
<b>CE:</b> 1 x G9 LED 3W 220V (190Lm)	01089407						
<b>US:</b> 1 x G9 LED 3W 110V (190Lm)							
<b>Certificates:</b>	CE, SASO						
<b>Physical characteristics:</b>	<p>1 Box / 17,9 x 24,9 x 42,3 cm / 0,019 m3</p> <p>1 Box / 7 x 9 3/4 x 16 3/4 inches / 1143 in3</p> <p>Gross weight 1,7 Kg. / Net weight 0,8 Kg.</p>						

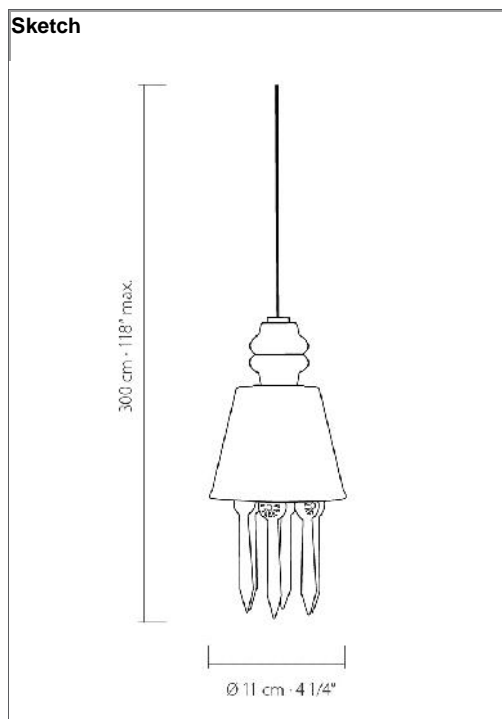

# Technical data sheet

**CE:** Ref 01023431 - UPC/EAN 737859234316  
**UK:** Ref 01023431 - UPC/EAN 737859234316  
**US:** Ref 01023432 - UPC/EAN 737859234316  
**JP:** Ref 01023433 - UPC/EAN 737859234316

**Description:**

**Belle de Nuit - pendant lamp I - multicolor**  
**Belle de Nuit - Lámpara de techo I - multicolor**

**Collection:**

**BELLE DE NUIT**

**Mounting:**

Pendant

**Environment:**

Hanging lamp body made of porcelain. Available in different finishes to match all decorative ambiances. Easy to fix to ceiling system and capable of changing length during installation. This model fits well on a corner display but also on reception desks.

**Installation and assembly:**

Follow instructions of the installation guide

**Electrical characteristics:**

**Max. Power:** 1 x 18W  
**Tension:** CE-UK: 220/240VAC US-JP: 100/125VAC  
**Frequency:** 50/60Hz  
 Dimmer not included

**Recommended Bulb**

Bulb not included	<b>Bulb reference</b>
<b>CE:</b> 1 x E27 LED 6W (600 Lm)	01089432
<b>US:</b> 1 x E26 LED 6W (600 Lm)	

**Certificates:**

CE, SASO  
UL

**Physical characteristics:**

1 Box / 9,153 x 100 x 100 cm / 0,092 m3  
 1 Box / 3 1/2 x 39 1/4 x 39 1/4 inches / 5392 in3  
 Gross weight 3,3 Kg. / Net weight 1,2 Kg.

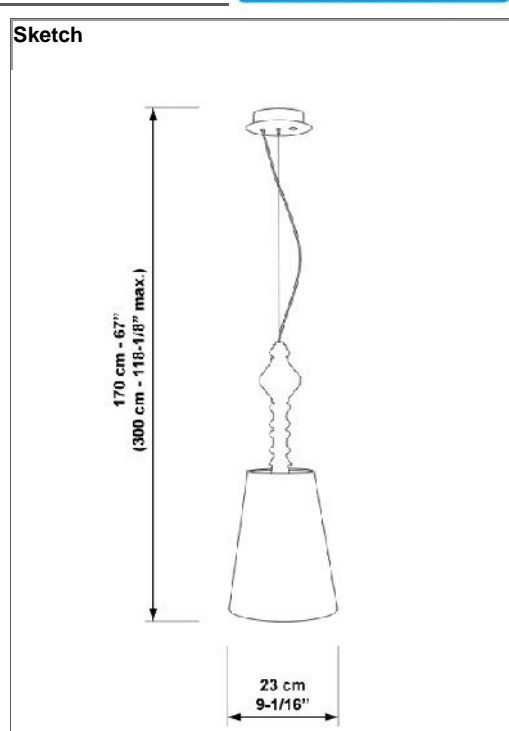

# Technical data sheet

**CE:** Ref 01023434 - UPC/EAN 737859234347  
**UK:** Ref 01023434 - UPC/EAN 737859234347  
**US:** Ref 01023435 - UPC/EAN 737859234347  
**JP:** Ref 01023436 - UPC/EAN 737859234347

**Description:**

**Belle de Nuit - pendant lamp II - multicolor**  
**Belle de Nuit - Lámpara de techo II - multicolor**

**Collection:**

**BELLE DE NUIT**

**Mounting:**

Pendant

**Environment:**

Hanging lamp body made of porcelain. Available in different finishes to match all decorative ambiances. Easy to fix to ceiling system and capable of changing length during installation. This model fits well on a corner display but also on reception desks.

**Installation and assembly:**

Follow instructions of the installation guide

**Electrical characteristics:**

**Max. Power:** 1 x 18W  
**Tension:** CE-UK: 220/240VAC US-JP: 100/125VAC  
**Frequency:** 50/60Hz  
 Dimmer not included

**Recommended Bulb**

Bulb not included	<b>Bulb reference</b>
<b>CE:</b> 1 x E27 LED 6W (600 Lm)	01089432
<b>US:</b> 1 x E26 LED 6W (600 Lm)	

**Certificates:**

CE, SASO  
UL

**Physical characteristics:**

1 Box / 10,694 x 100 x 100 cm / 0,107 m3  
 1 Box / 4 1/4 x 39 1/4 x 39 1/4 inches / 6547 in3  
 Gross weight 4,1 Kg. / Net weight 1,8 Kg.

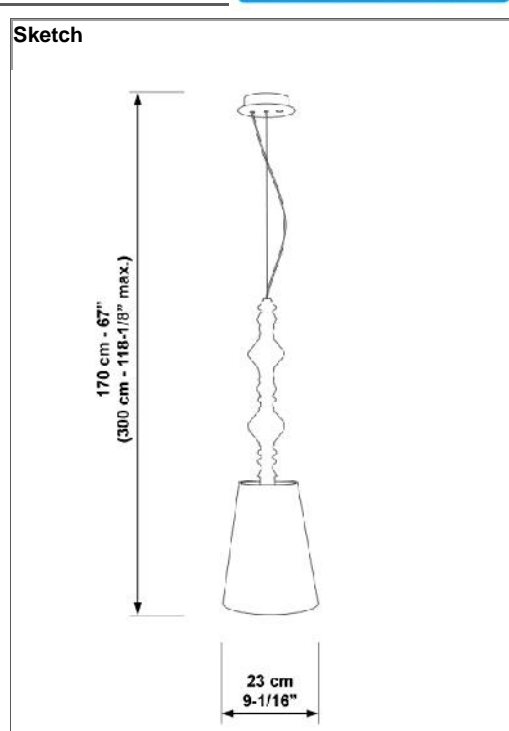
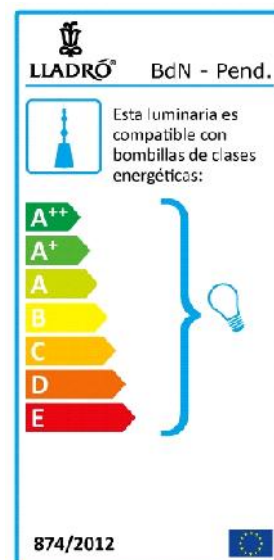

# Technical data sheet

**CE:** Ref 01023437 - UPC/EAN 737859234378  
**UK:** Ref 01023438 - UPC/EAN 737859234378  
**US:** Ref 01023439 - UPC/EAN 737859234378  
**JP:** Ref 01023440 - UPC/EAN 737859234378

**Description:**

**Belle de Nuit - Floor Lamp I - multicolor**  
**Belle de Nuit - Lámpara de pie I - multicolor**

**Collection:**

**BELLE DE NUIT**

**Mounting:**

Floor lamp

**Environment:**

Standing lamp body made of porcelain. Available in different finishes to match all decorative ambiances. This model fits well alone or in combination with other items from the same collection

**Installation and assembly:**

Follow instructions of the installation guide

**Electrical characteristics:**

**Max. Power:** 1 x 18W  
**Tension:** CE-UK: 220/240VAC US-JP: 100/125VAC  
**Frequency:** 50/60Hz

**Recommended Bulb**

Bulb not included **Bulb reference**  
**CE:** 1 x E27 LED 6W (600 Lm)  
**US:** 1 x E26 LED 6W (600 Lm)

**Certificates:**

CE, SASO  
 UL

**Physical characteristics:**

1 Box / 35 x 33 x 193 cm / 0,223 m3  
 1 Box / 13 3/4 x 13 x 76 inches / 13585 in3  
 Gross weight 7,7 Kg. / Net weight 3,9 Kg.



**Sketch**

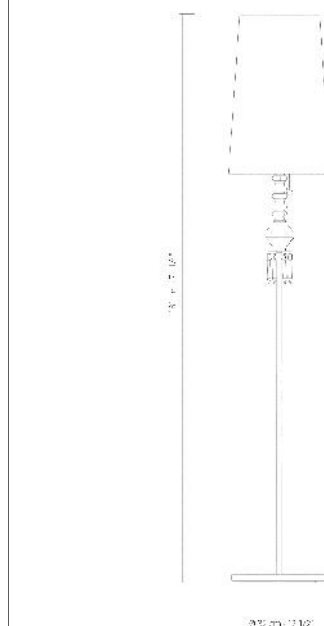



# Technical data sheet

**CE:** Ref 01023441 - UPC/EAN 737859234415  
**UK:** Ref 01023442 - UPC/EAN 737859234415  
**US:** Ref 01023443 - UPC/EAN 737859234415  
**JP:** Ref 01023444 - UPC/EAN 737859234415

**Description:**

**Belle de Nuit - Floor Lamp II - multicolor**  
**Belle de Nuit - Lámpara de pie II - multicolor**

**Collection:**

**BELLE DE NUIT**

**Mounting:**

Floor lamp

**Environment:**

Standing lamp body made of porcelain. Available in different finishes to match all decorative ambiances. This model fits well alone or in combination with other items from the same collection

**Installation and assembly:**

Follow instructions of the installation guide

**Electrical characteristics:**

**Max. Power:** 1 x 18W  
**Tension:** CE-UK: 220/240VAC US-JP: 100/125VAC  
**Frequency:** 50/60Hz

**Recommended Bulb**

Bulb not included **Bulb reference**  
**CE:** 1 x E27 LED 6W (600 Lm)  
**US:** 1 x E26 LED 6W (600 Lm)

**Certificates:**

CE, SASO  
 UL

**Physical characteristics:**

1 Box / 35 x 33 x 193 cm / 0,223 m3  
 1 Box / 13 3/4 x 13 x 76 inches / 13585 in3  
 Gross weight 8,6 Kg. / Net weight 4,2 Kg.



**Sketch**

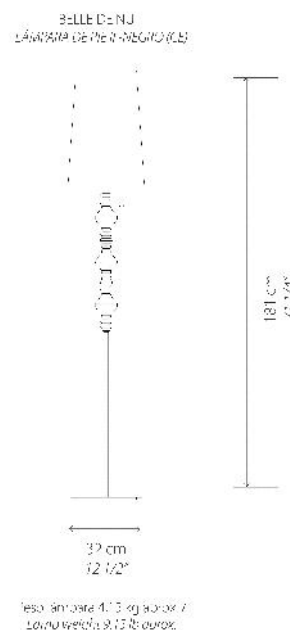

# Technical data sheet

**CE:** Ref 01023445 - UPC/EAN 737859234453  
**UK:** Ref 01023445 - UPC/EAN 737859234453  
**US:** Ref 01023446 - UPC/EAN 737859234453  
**JP:** Ref 01023447 - UPC/EAN 737859234453

**Description:**

**Belle de Nuit - lithophane hanging lamp - multicolor**  
**Belle de Nuit - Lámpara litofanía colgante - multicolor**

**Collection:**

*BELLE DE NUIT*

**Mounting:**

Pendant

**Environment:**

Both hanging lamp body and lampshade are made of porcelain. Available in different finishes to match all decorative ambiances. Easy to fix to ceiling system and capable of changing length during installation. This model fits well on a corner display

**Installation and assembly:**

Follow instructions of the installation guide

**Electrical characteristics:**

**Max. Power:** 1 x 18W  
**Tension:** CE-UK: 220/240VAC US-JP: 100/125VAC  
**Frequency:** 50/60Hz

**Recommended Bulb**

Bulb not included **Bulb reference**  
**CE:** 1 x G9 LED 3W 220V (190Lm)  
**US:** 1 x G9 LED 3W 110V (190Lm)

**Certificates:**

**Physical characteristics:**

1 Box / 17,9 x 24,9 x 42,3 cm / 0,019 m3  
 1 Box / 7 x 9 3/4 x 16 3/4 inches / 1143 in3  
 Gross weight 1,7 Kg. / Net weight 0,8 Kg.



**Sketch**

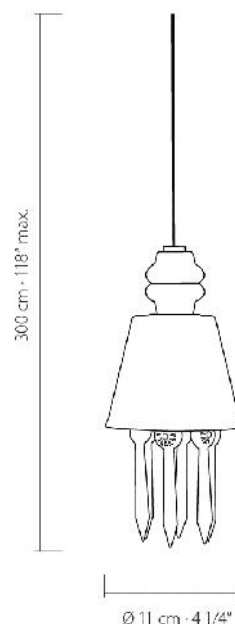

# Technical data sheet

**CE:** Ref 01023448 - UPC/EAN 737859234484  
**UK:** Ref 01023448 - UPC/EAN 737859234484  
**US:** Ref 01023449 - UPC/EAN 737859234484  
**JP:** Ref 01023450 - UPC/EAN 737859234484

**Description:**

**Belle de Nuit - pendant lamp I - gold**  
**Belle de Nuit - Lámpara de techo I - oro**

**Collection:**

*BELLE DE NUIT*

**Mounting:**

Pendant

**Environment:**

Hanging lamp body made of porcelain. Available in different finishes to match all decorative ambiances. Easy to fix to ceiling system and capable of changing length during installation. This model fits well on a corner display but also on reception desks.

**Installation and assembly:**

Follow instructions of the installation guide

**Electrical characteristics:**

**Max. Power:** 1 x 18W  
**Tension:** CE-UK: 220/240VAC US-JP: 100/125VAC  
**Frequency:** 50/60Hz  
 Dimmer not included

**Recommended Bulb**

Bulb not included	<b>Bulb reference</b>
<b>CE:</b> 1 x E27 LED 6W (600 Lm)	01089432
<b>US:</b> 1 x E26 LED 6W (600 Lm)	

**Certificates:**

CE, SASO  
 UL

**Physical characteristics:**

1 Box / 9,153 x 100 x 100 cm / 0,092 m3  
 1 Box / 3 1/2 x 39 1/4 x 39 1/4 inches / 5392 in3  
 Gross weight 3,3 Kg. / Net weight 1,2 Kg.

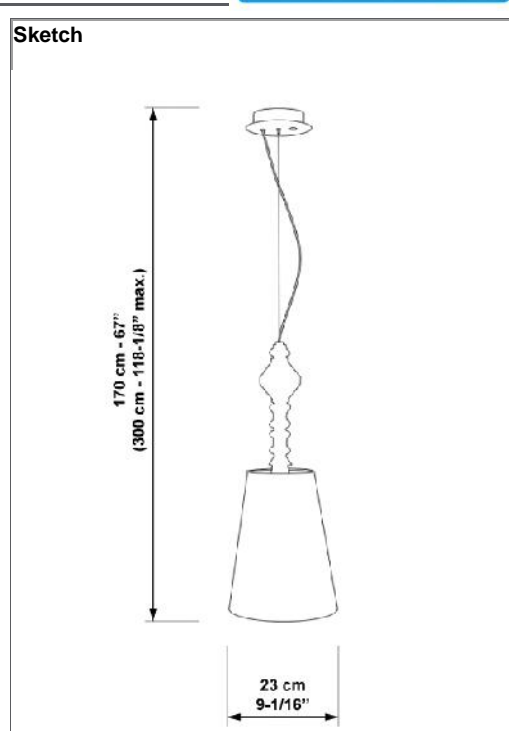
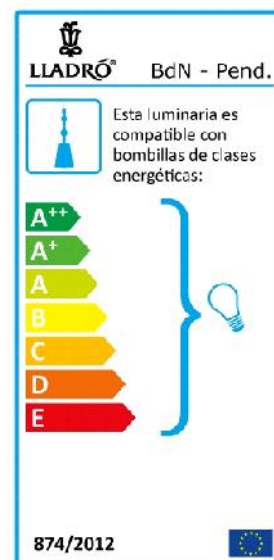

# Technical data sheet

**CE:** Ref 01023451 - UPC/EAN 737859234514  
**UK:** Ref 01023451 - UPC/EAN 737859234514  
**US:** Ref 01023452 - UPC/EAN 737859234514  
**JP:** Ref 01023453 - UPC/EAN 737859234514

**Description:**

**Belle de Nuit - pendant lamp II - gold**  
**Belle de Nuit - Lámpara de techo II - oro**

**Collection:**

*BELLE DE NUIT*

**Mounting:**

Pendant

**Environment:**

Hanging lamp body made of porcelain. Available in different finishes to match all decorative ambiances. Easy to fix to ceiling system and capable of changing length during installation. This model fits well on a corner display but also on reception desks.

**Installation and assembly:**

Follow instructions of the installation guide

**Electrical characteristics:**

**Max. Power:** 1 x 18W  
**Tension:** CE-UK: 220/240VAC US-JP: 100/125VAC  
**Frequency:** 50/60Hz

**Recommended Bulb**

Bulb not included	<b>Bulb reference</b>
<b>CE:</b> 1 x E27 LED 6W (600 Lm)	01089432
<b>US:</b> 1 x E26 LED 6W (600 Lm)	

**Certificates:**

CE, SASO, CCC  
 UL

**Physical characteristics:**

1 Box / 10,694 x 100 x 100 cm / 0,107 m3  
 1 Box / 4 1/4 x 39 1/4 x 39 1/4 inches / 6547 in3  
 Gross weight 4,1 Kg. / Net weight 1,8 Kg.

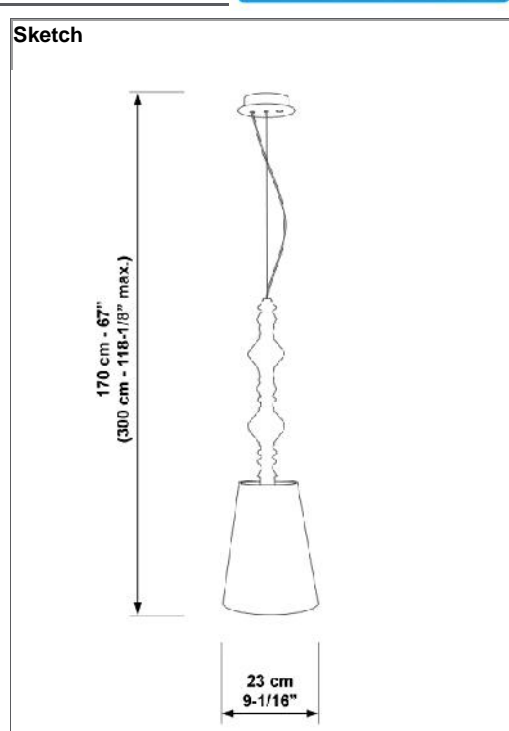
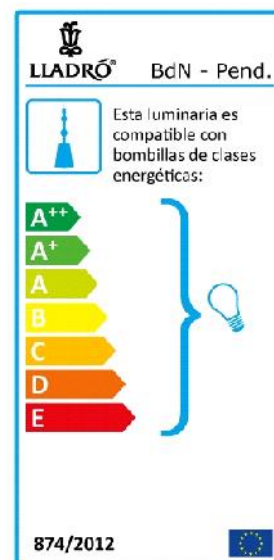

# Technical data sheet

**CE:** Ref 01023454 - UPC/EAN 737859234545  
**UK:** Ref 01023455 - UPC/EAN 737859234545  
**US:** Ref 01023456 - UPC/EAN 737859234545  
**JP:** Ref 01023457 - UPC/EAN 737859234545

**Description:**

**Belle de Nuit - Floor Lamp I - gold**  
**Belle de Nuit - Lámpara de pie I - oro**

**Collection:**

**BELLE DE NUIT**

**Mounting:**

Floor lamp

**Environment:**

Standing lamp body made of porcelain. Available in different finishes to match all decorative ambiances. This model fits well alone or in combination with other items from the same collection

**Installation and assembly:**

Follow instructions of the installation guide

**Electrical characteristics:**

**Max. Power:** 1 x 18W  
**Tension:** CE-UK: 220/240VAC US-JP: 100/125VAC  
**Frequency:** 50/60Hz

**Recommended Bulb**

Bulb not included **Bulb reference**  
**CE:** 1 x E27 LED 6W (600 Lm)  
**US:** 1 x E26 LED 6W (600 Lm)

**Certificates:**

CE, SASO  
 UL

**Physical characteristics:**

1 Box / 35 x 33 x 193 cm / 0,223 m3  
 1 Box / 13 3/4 x 13 x 76 inches / 13585 in3  
 Gross weight 7,7 Kg. / Net weight 3,9 Kg.



**Sketch**

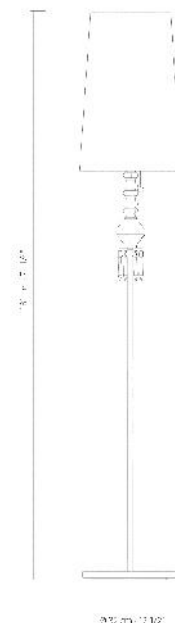

# Technical data sheet

<b>CE:</b>	Ref 01023458 - UPC/EAN 737859234583
<b>UK:</b>	Ref 01023459 - UPC/EAN 737859234583
<b>US:</b>	Ref 01023460 - UPC/EAN 737859234583
<b>JP:</b>	Ref 01023461 - UPC/EAN 737859234583

<b>Description:</b>	<b>Belle de Nuit - Floor Lamp II - gold</b> <b>Belle de Nuit - Lámpara de pie II - oro</b>
<b>Collection:</b>	<b>BELLE DE NUIT</b>
<b>Mounting:</b>	Floor lamp
<b>Environment:</b>	Standing lamp body made of porcelain. Available in different finishes to match all decorative ambiances. This model fits well alone or in combination with other items from the same collection
<b>Installation and assembly:</b>	Follow instructions of the installation guide
<b>Electrical characteristics:</b>	<b>Max. Power:</b> 1 x 18W <b>Tension:</b> CE-UK: 220/240VAC US-JP: 100/125VAC <b>Frequency:</b> 50/60Hz
<b>Recommended Bulb</b>	<b>Bulb not included</b> <span style="float: right;"><b>Bulb reference</b></span> <b>CE:</b> 1 x E27 LED 6W (600 Lm) <b>US:</b> 1 x E26 LED 6W (600 Lm)
<b>Certificates:</b>	CE, SASO UL
<b>Physical characteristics:</b>	1 Box / 35 x 33 x 193 cm / 0,223 m3 1 Box / 13 3/4 x 13 x 76 inches / 13585 in3 Gross weight 8,6 Kg. / Net weight 4,2 Kg.



Sketch

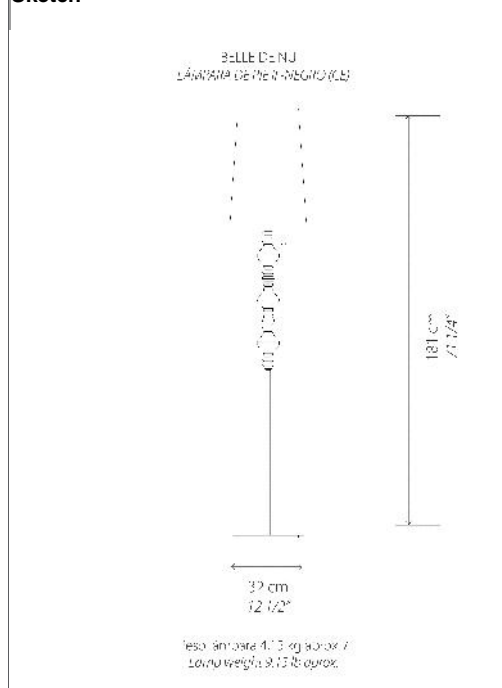

# Technical data sheet

<b>CE:</b>	Ref 01023462 - UPC/EAN 737859234620
<b>UK:</b>	Ref 01023462 - UPC/EAN 737859234620
<b>US:</b>	Ref 01023463 - UPC/EAN 737859234620
<b>JP:</b>	Ref 01023464 - UPC/EAN 737859234620

<b>Description:</b>	<b>Belle de Nuit - lithophane hanging lamp - gold</b> <b>Belle de Nuit - Lámpara litofanía colgante - oro</b>						
<b>Collection:</b>	<b>BELLE DE NUIT</b>						
<b>Mounting:</b>	Pendant						
<b>Environment:</b>	Both hanging lamp body and lampshade are made of porcelain. Available in different finishes to match all decorative ambiances. Easy to fix to ceiling system and capable of changing length during installation. This model fits well on a corner display						
<b>Installation and assembly:</b>	Follow instructions of the installation guide						
<b>Electrical characteristics:</b>	<p><b>Max. Power:</b> 1 x 18W</p> <p><b>Tension:</b> CE-UK: 220/240VAC US-JP: 100/125VAC</p> <p><b>Frequency:</b> 50/60Hz</p>						
<b>Recommended Bulb</b>	<table border="1"> <thead> <tr> <th>Bulb not included</th> <th>Bulb reference</th> </tr> </thead> <tbody> <tr> <td><b>CE:</b> 1 x G9 LED 3W 220V (190Lm)</td> <td>01089407</td> </tr> <tr> <td><b>US:</b> 1 x G9 LED 3W 110V (190Lm)</td> <td></td> </tr> </tbody> </table>	Bulb not included	Bulb reference	<b>CE:</b> 1 x G9 LED 3W 220V (190Lm)	01089407	<b>US:</b> 1 x G9 LED 3W 110V (190Lm)	
Bulb not included	Bulb reference						
<b>CE:</b> 1 x G9 LED 3W 220V (190Lm)	01089407						
<b>US:</b> 1 x G9 LED 3W 110V (190Lm)							
<b>Certificates:</b>	CE, SASO						
<b>Physical characteristics:</b>	<p>1 Box / 17,9 x 24,9 x 42,3 cm / 0,019 m3</p> <p>1 Box / 7 x 9 3/4 x 16 3/4 inches / 1143 in3</p> <p>Gross weight 1,7 Kg. / Net weight 0,8 Kg.</p>						

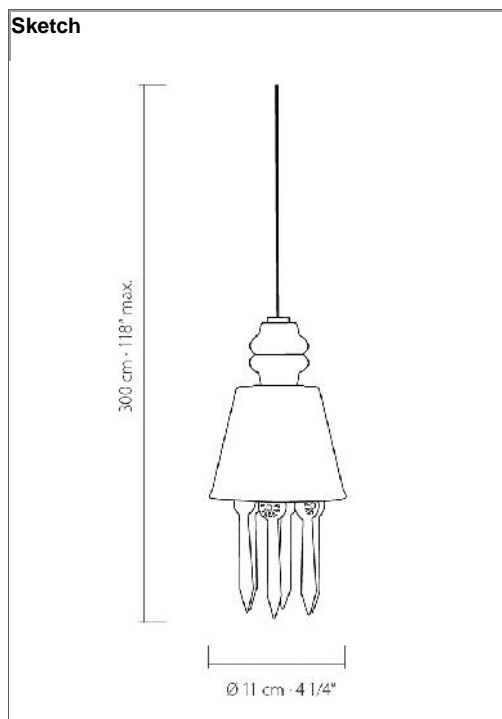

# Technical data sheet

**CE:** Ref 01023746 - UPC/EAN 737859237461  
**UK:** Ref 01023746 - UPC/EAN 737859237461  
**US:** Ref 01023747 - UPC/EAN 737859237461  
**JP:** Ref 01023748 - UPC/EAN 737859237461

**Description:**

**Belle de Nuit - Chandelier 12 lights - absolute black**  
**Belle de Nuit - Chandelier 12 luces - negro absoluto**

**Collection:**

**BELLE DE NUIT**

**Mounting:**

Chandelier

**Environment:**

Chandelier entirely made of porcelain. Made in different finishes to match all decorative ambiences. Not very heavy to simplify its installation. Bespoke measures available under request.

**Installation and assembly:**

Follow instructions of the installation guide

**Electrical characteristics:**

**Max. Power:** 12 x 18W  
**Tension:** CE-UK: 220/240VAC US-JP: 100/125VAC  
**Frequency:** 50/60Hz  
 Dimmer not included / LED bulb non dimmable

**Recommended Bulb**

Bulb not included	<b>Bulb reference</b>
<b>CE:</b> 12 x G9 Led 3W 220V (190Lm)	1089407
<b>US:</b> 12 x G9 Led 3W 110V (190Lm)	

**Certificates:**

CE, SASO  
UL

**Physical characteristics:**

1 Box / 111 x 82 x 82 cm / 0,746 m3  
 1 Box / 43 3/4 x 32 1/4 x 32 1/4 inches / 45503 in3  
 Gross weight 36 Kg. / Net weight 8,3 Kg.

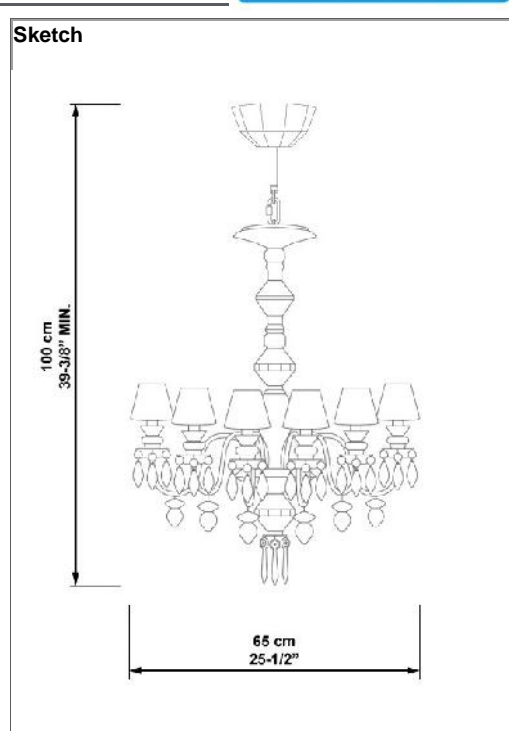
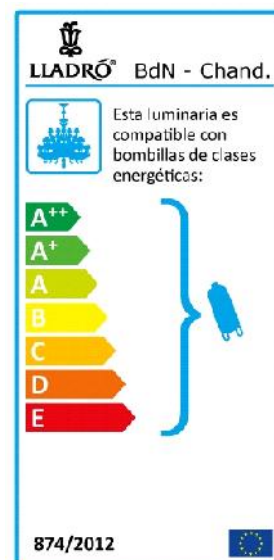



# Technical data sheet

<b>CE:</b>	Ref 01023749 - UPC/EAN 737859237492
<b>UK:</b>	Ref 01023749 - UPC/EAN 737859237492
<b>US:</b>	Ref 01023750 - UPC/EAN 737859237492
<b>JP:</b>	Ref 01023751 - UPC/EAN 737859237492

**Description:**

**Belle de Nuit - Chandelier 24 lights - absolute black**  
**Belle de Nuit - Chandelier 24 luces - negro absoluto**

**Collection:**

**BELLE DE NUIT**

**Mounting:**

Chandelier

**Environment:**

Chandelier entirely made of porcelain. Made in different finishes to match all decorative ambiences. Not very heavy to simplify its installation. Bespoke measures available under request.

**Installation and assembly:**

Follow instructions of the installation guide

**Electrical characteristics:**

**Max. Power:** 24 x 18W  
**Tension:** CE-UK: 220/240VAC US-JP: 100/125VAC  
**Frequency:** 50/60Hz  
Dimmer not included / LED bulb non dimmable

**Recommended Bulb**

Bulb not included	Bulb reference
<b>CE:</b> 24 x G9 Led 3W 220V (190Lm)	01089407
<b>US:</b> 24 x G9 Led 3W 110V (190Lm)	

**Certificates:**

CE, SASO  
UL

**Physical characteristics:**

1 Box / 135 x 105 x 105 cm / 1,488 m3  
1 Box / 53 1/4 x 41 1/4 x 41 1/4 inches / 90608 in3  
Gross weight 44,1 kg. / Net weight 21,2 kg.

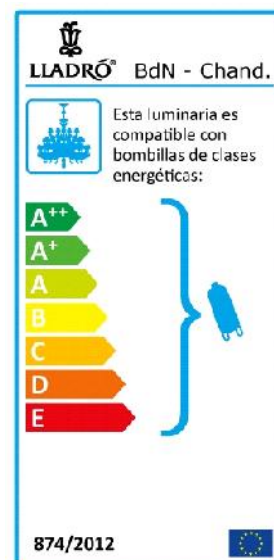

**Sketch**

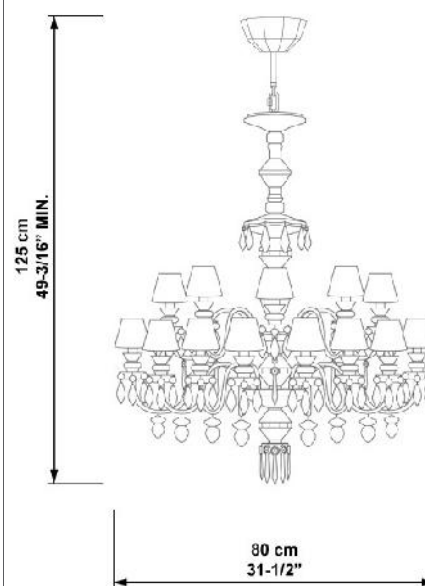

# Technical data sheet

**CE:** Ref 01023752 - UPC/EAN 737859237522  
**UK:** Ref 01023752 - UPC/EAN 737859237522  
**US:** Ref 01023753 - UPC/EAN 737859237522  
**JP:** Ref 01023754 - UPC/EAN 737859237522

**Description:**

**Belle de Nuit - Chandelier 40 lights - absolute black**  
**Belle de Nuit - Chandelier 40 luces - negro absoluto**

**Collection:**

**BELLE DE NUIT**

**Mounting:**

Chandelier

**Environment:**

Chandelier entirely made of porcelain. Made in different finishes to match all decorative ambiences. Not very heavy to simplify its installation. Bespoke measures available under request.

**Installation and assembly:**

Follow instructions of the installation guide

**Electrical characteristics:**

**Max. Power:** 40 x 18W  
**Tension:** CE-UK: 220/240VAC US-JP: 100/125VAC  
**Frequency:** 50/60Hz  
 Dimmer not included / LED bulb non dimmable

**Recommended Bulb**

Bulb not included	<b>Bulb reference</b>
<b>CE:</b> 40 x G9 Led 3W 220V (190Lm)	01089407
<b>US:</b> 40 x G9 Led 3W 110V (190Lm)	

**Certificates:**

CE, SASO  
UL

**Physical characteristics:**

1 Box / 140 x 119 x 119 cm / 1,983 m3  
 1 Box / 55 x 46 3/4 x 46 3/4 inches / 120206 in3  
 Gross weight 129,6 kg. / Net weight 27,4 kg.

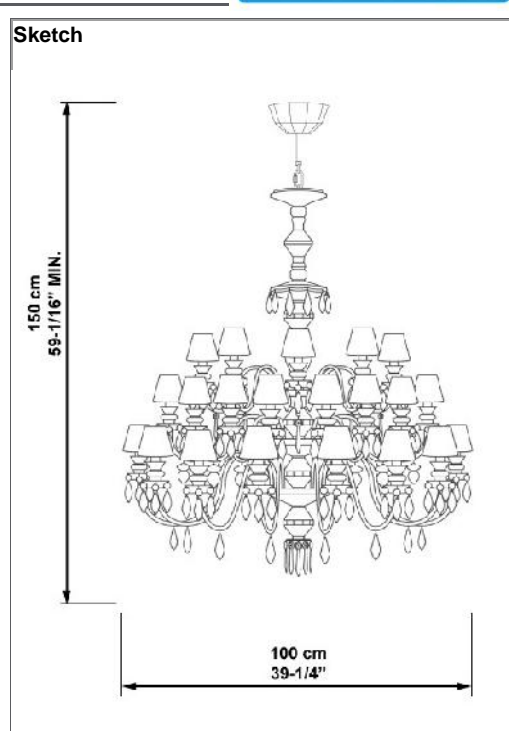
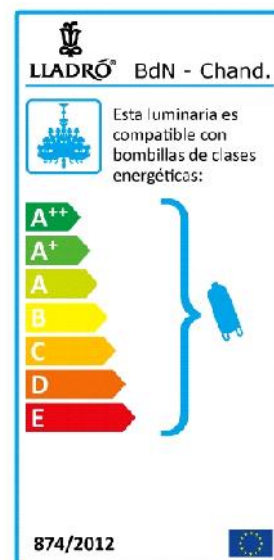

# Technical data sheet

**CE:** Ref 01023768 - UPC/EAN 737859237683  
**UK:** Ref 01023768 - UPC/EAN 737859237683  
**US:** Ref 01023769 - UPC/EAN 737859237683  
**JP:** Ref 01023770 - UPC/EAN 737859237683

**Description:**

**Belle de Nuit - Chandelier 56 lights. White**  
**Belle de Nuit - Chandelier 56 luces. Blanco**

**Collection:**

**BELLE DE NUIT**

**Mounting:**

Chandelier

**Environment:**

Belle de Nuit is a special plant. During the night, its petals seem to reflect the moonlight, and take on the magical property of glowing in the dark. The flower opens in the evening which is why it is also known in English as the four o'clock flower. It has a multitude of colors and mottled flowers with countless nuances. When the plant matures, its colors change and a yellow flower becomes a deep pink while a white flower becomes violet.

**Installation and assembly:**

Follow instructions of the installation guide

**Electrical characteristics:**

**Max. Power:** 56 x 18W  
**Tension:** CE-UK: 220/240VAC US-JP: 100/125VAC  
**Frequency:** 50/60Hz  
 Dimmer not included / LED bulb non dimmable

**Recommended Bulb**

Bulb not included	<b>Bulb reference</b>
<b>CE:</b> 56 x G9 Led 3W 220V (190Lm)	01089407
<b>US:</b> 56 x G9 Led 3W 110V (190Lm)	

**Certificates:**

CE  
UL

**Physical characteristics:**

1 Box / 265,05 x 100 x 100 cm / 2,65 m3  
 1 Box / 104 1/4 x 39 1/4 x 39 1/4 inches / 160604 in3  
 Gross weight 200 Kg. / Net weight 48,7 Kg.



**LLADRÓ** BdN - Chand.

Esta luminaria es compatible con bombillas de clases energéticas:

A++  
A+  
A  
B  
C  
D  
E

874/2012 

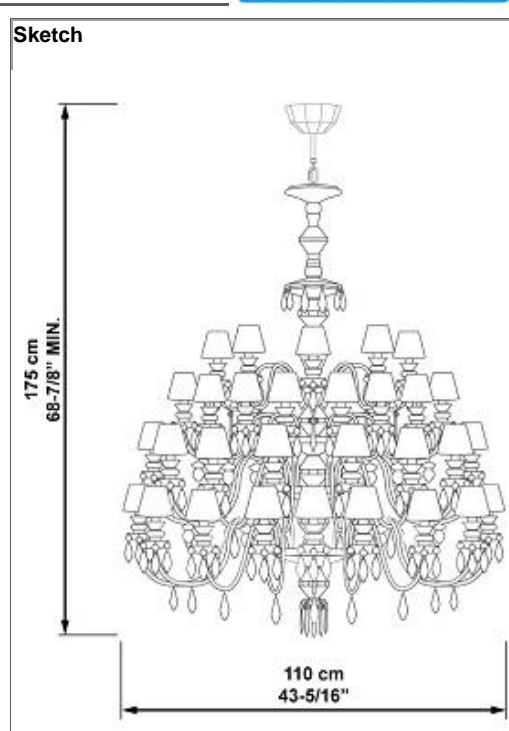

# Technical data sheet

**CE:** Ref 01023771 - UPC/EAN 737859237713  
**UK:** Ref 01023771 - UPC/EAN 737859237713  
**US:** Ref 01023772 - UPC/EAN 737859237713  
**JP:** Ref 01023773 - UPC/EAN 737859237713

**Description:**

**Belle de Nuit - Chandelier 56 lights. Black**  
**Belle de Nuit - Chandelier 56 luces. Negro**

**Collection:**

**BELLE DE NUIT**

**Mounting:**

Chandelier

**Environment:**

Belle de Nuit is a special plant. During the night, its petals seem to reflect the moonlight, and take on the magical property of glowing in the dark. The flower opens in the evening which is why it is also known in English as the four o'clock flower. It has a multitude of colors and mottled flowers with countless nuances. When the plant matures, its colors change and a yellow flower becomes a deep pink while a white flower becomes violet.

**Installation and assembly:**

Follow instructions of the installation guide

**Electrical characteristics:**

**Max. Power:** 56 x 18W  
**Tension:** CE-UK: 220/240VAC US-JP: 100/125VAC  
**Frequency:** 50/60Hz  
 Dimmer not included / LED bulb non dimmable

**Recommended Bulb**

Bulb not included	<b>Bulb reference</b>
<b>CE:</b> 56 x G9 Led 3W 220V (190Lm)	01089407
<b>US:</b> 56 x G9 Led 3W 110V (190Lm)	

**Certificates:**

CE  
UL

**Physical characteristics:**

1 Box / 265,05 x 100 x 100 cm / 2,65 m3  
 1 Box / 104 1/4 x 39 1/4 x 39 1/4 inches / 160604 in3  
 Gross weight 200 Kg. / Net weight 48,7 Kg.



**LLADRÓ** BdN - Chand.

Esta luminaria es compatible con bombillas de clases energéticas:

A++  
A+  
A  
B  
C  
D  
E

874/2012

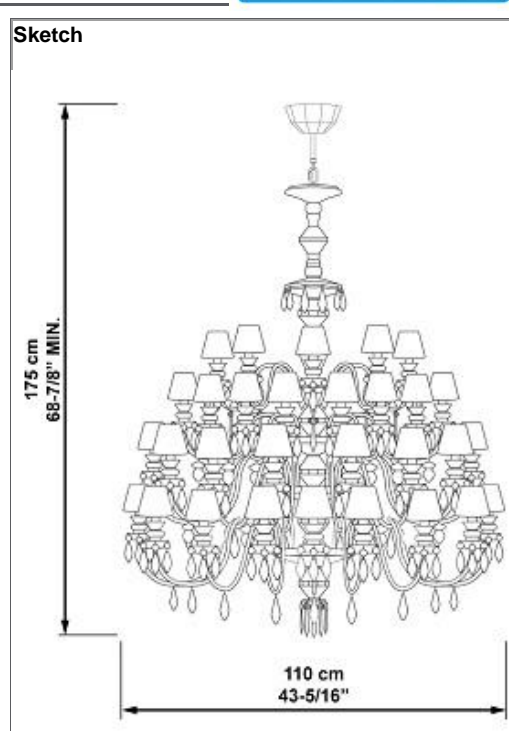

# Technical data sheet

**CE:** Ref 01023774 - UPC/EAN 737859237744  
**UK:** Ref 01023774 - UPC/EAN 737859237744  
**US:** Ref 01023775 - UPC/EAN 737859237744  
**JP:** Ref 01023776 - UPC/EAN 737859237744

**Description:**

**Belle de Nuit - Chandelier 56 lights - green**  
**Belle de Nuit - Chandelier 56 luces - verde**

**Collection:**

**BELLE DE NUIT**

**Mounting:**

Chandelier

**Environment:**

Belle de Nuit is a special plant. During the night, its petals seem to reflect the moonlight, and take on the magical property of glowing in the dark. The flower opens in the evening which is why it is also known in English as the four o'clock flower. It has a multitude of colors and mottled flowers with countless nuances. When the plant matures, its colors change and a yellow flower becomes a deep pink while a white flower becomes violet.

**Installation and assembly:**

Follow instructions of the installation guide

**Electrical characteristics:**

**Max. Power:** 56 x 18W  
**Tension:** CE-UK: 220/240VAC US-JP: 100/125VAC  
**Frequency:** 50/60Hz  
 Dimmer not included / LED bulb non dimmable

**Recommended Bulb**

Bulb not included	<b>Bulb reference</b>
<b>CE:</b> 56 x G9 Led 3W 220V (190Lm)	01089407
<b>US:</b> 56 x G9 Led 3W 110V (190Lm)	

**Certificates:**

CE  
UL

**Physical characteristics:**

1 Box / 265,05 x 100 x 100 cm / 2,65 m3  
 1 Box / 104 1/4 x 39 1/4 x 39 1/4 inches / 160604 in3  
 Gross weight 200 Kg. / Net weight 48,7 Kg.

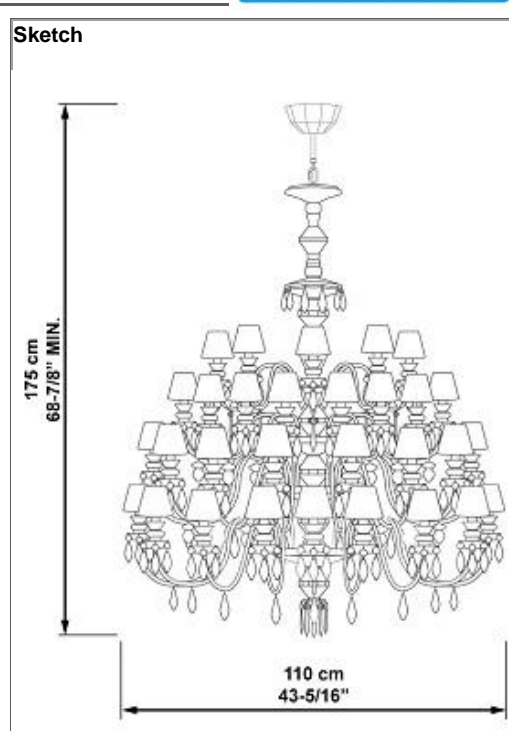
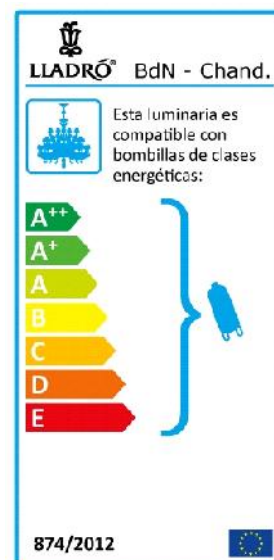

# Technical data sheet

**CE:** Ref 01023777 - UPC/EAN 737859237775  
**UK:** Ref 01023777 - UPC/EAN 737859237775  
**US:** Ref 01023778 - UPC/EAN 737859237775  
**JP:** Ref 01023779 - UPC/EAN 737859237775

**Description:**

**Belle de Nuit - Chandelier 56 lights. Blue**  
**Belle de Nuit - Chandelier 56 luces. Azul**

**Collection:**

**BELLE DE NUIT**

**Mounting:**

Chandelier

**Environment:**

Belle de Nuit is a special plant. During the night, its petals seem to reflect the moonlight, and take on the magical property of glowing in the dark. The flower opens in the evening which is why it is also known in English as the four o'clock flower. It has a multitude of colors and mottled flowers with countless nuances. When the plant matures, its colors change and a yellow flower becomes a deep pink while a white flower becomes violet.

**Installation and assembly:**

Follow instructions of the installation guide

**Electrical characteristics:**

**Max. Power:** 56 x 18W  
**Tension:** CE-UK: 220/240VAC US-JP: 100/125VAC  
**Frequency:** 50/60Hz  
 Dimmer not included / LED bulb non dimmable

**Recommended Bulb**

Bulb not included	<b>Bulb reference</b>
<b>CE:</b> 56 x G9 Led 3W 220V (190Lm)	01089407
<b>US:</b> 56 x G9 Led 3W 110V (190Lm)	

**Certificates:**

CE  
UL

**Physical characteristics:**

1 Box / 265,05 x 100 x 100 cm / 2,65 m3  
 1 Box / 104 1/4 x 39 1/4 x 39 1/4 inches / 160604 in3  
 Gross weight 200 Kg. / Net weight 48,7 Kg.

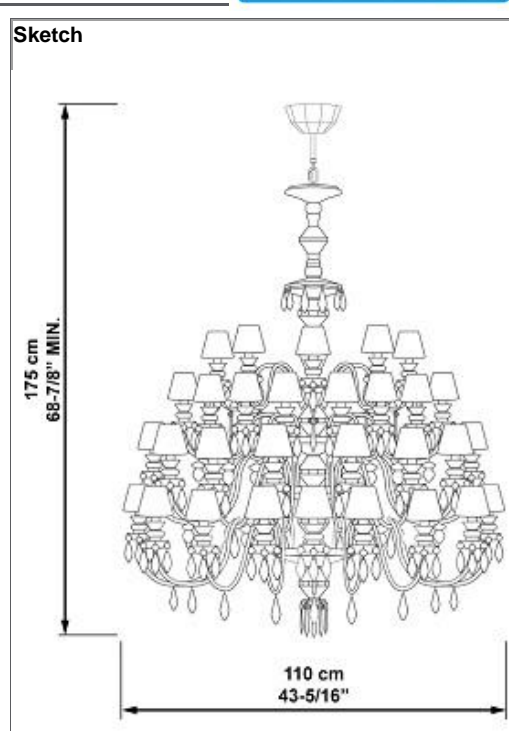
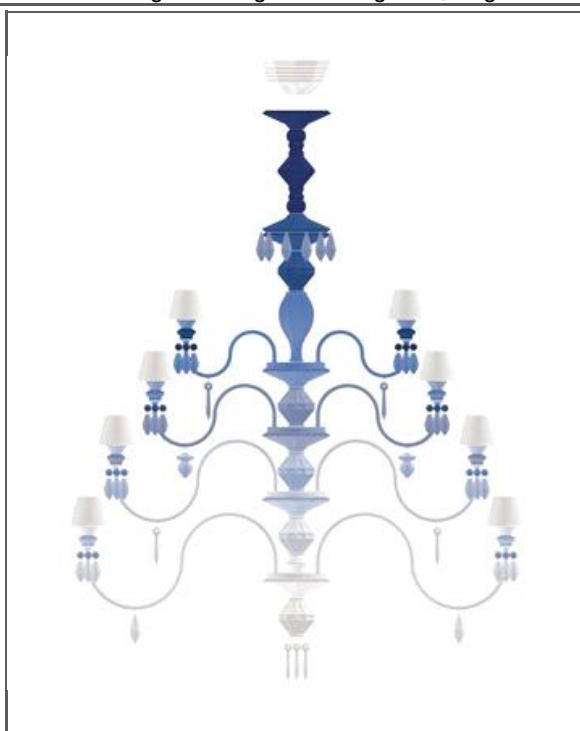

# Technical data sheet

**CE:** Ref 01023780 - UPC/EAN 737859237805  
**UK:** Ref 01023780 - UPC/EAN 737859237805  
**US:** Ref 01023781 - UPC/EAN 737859237805  
**JP:** Ref 01023782 - UPC/EAN 737859237805

**Description:**

**Belle de Nuit - Chandelier 56 lights - pink**  
**Belle de Nuit - Chandelier 56 luces - rosa**

**Collection:**

**BELLE DE NUIT**

**Mounting:**

Chandelier

**Environment:**

Belle de Nuit is a special plant. During the night, its petals seem to reflect the moonlight, and take on the magical property of glowing in the dark. The flower opens in the evening which is why it is also known in English as the four o'clock flower. It has a multitude of colors and mottled flowers with countless nuances. When the plant matures, its colors change and a yellow flower becomes a deep pink while a white flower becomes violet.

**Installation and assembly:**

Follow instructions of the installation guide

**Electrical characteristics:**

**Max. Power:** 56 x 18W  
**Tension:** CE-UK: 220/240VAC US-JP: 100/125VAC  
**Frequency:** 50/60Hz  
 Dimmer not included / LED bulb non dimmable

**Recommended Bulb**

Bulb not included	<b>Bulb reference</b>
<b>CE:</b> 56 x G9 Led 3W 220V (190Lm)	01089407
<b>US:</b> 56 x G9 Led 3W 110V (190Lm)	

**Certificates:**

CE  
UL

**Physical characteristics:**

1 Box / 265,05 x 100 x 100 cm / 2,65 m3  
 1 Box / 104 1/4 x 39 1/4 x 39 1/4 inches / 160604 in3  
 Gross weight 200 Kg. / Net weight 48,7 Kg.

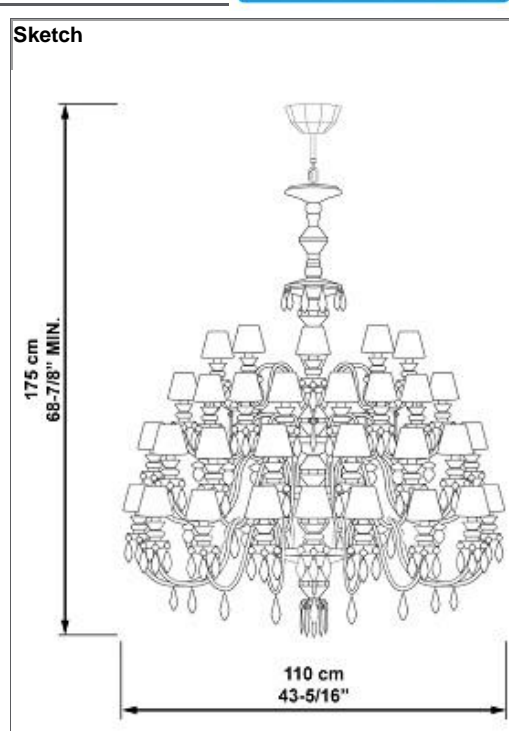
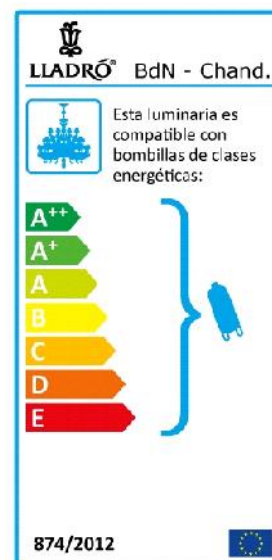

# Technical data sheet

**CE:** Ref 01023783 - UPC/EAN 737859237836  
**UK:** Ref 01023783 - UPC/EAN 737859237836  
**US:** Ref 01023784 - UPC/EAN 737859237836  
**JP:** Ref 01023785 - UPC/EAN 737859237836

**Description:**

**Belle de Nuit - Chandelier 56 lights. Multicolor**  
**Belle de Nuit - Chandelier 56 luces. Multicolor**

**Collection:**

**BELLE DE NUIT**

**Mounting:**

Chandelier

**Environment:**

Belle de Nuit is a special plant. During the night, its petals seem to reflect the moonlight, and take on the magical property of glowing in the dark. The flower opens in the evening which is why it is also known in English as the four o'clock flower. It has a multitude of colors and mottled flowers with countless nuances. When the plant matures, its colors change and a yellow flower becomes a deep pink while a white flower becomes violet.

**Installation and assembly:**

Follow instructions of the installation guide

**Electrical characteristics:**

**Max. Power:** 56 x 18W  
**Tension:** CE-UK: 220/240VAC US-JP: 100/125VAC  
**Frequency:** 50/60Hz  
 Dimmer not included / LED bulb non dimmable

**Recommended Bulb**

Bulb not included	<b>Bulb reference</b>
<b>CE:</b> 56 x G9 Led 3W 220V (190Lm)	01089407
<b>US:</b> 56 x G9 Led 3W 110V (190Lm)	

**Certificates:**

CE  
UL

**Physical characteristics:**

1 Box / 265,05 x 100 x 100 cm / 2,65 m3  
 1 Box / 104 1/4 x 39 1/4 x 39 1/4 inches / 160604 in3  
 Gross weight 200 Kg. / Net weight 48,7 Kg.

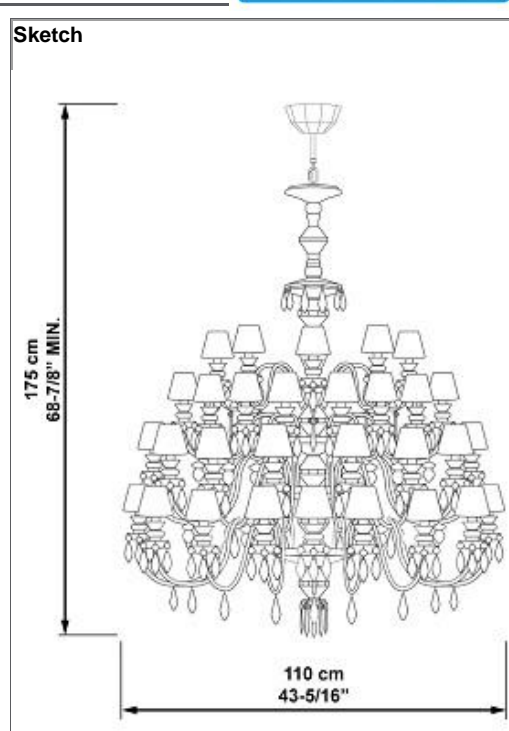
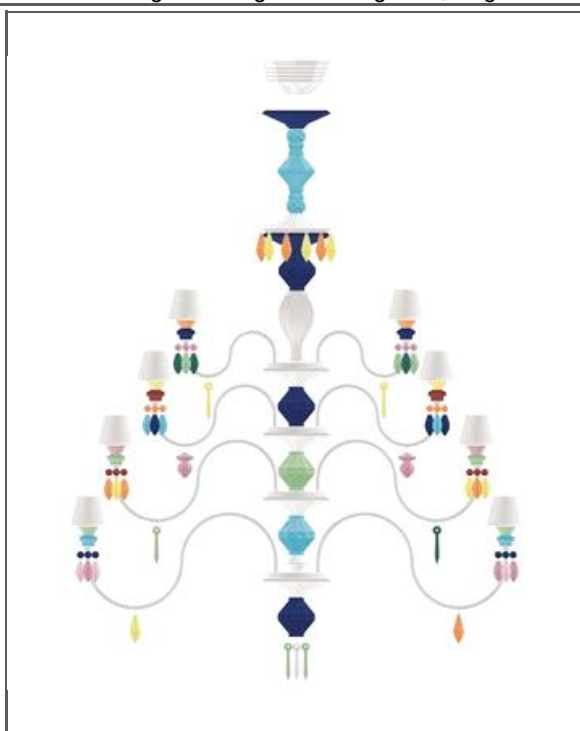
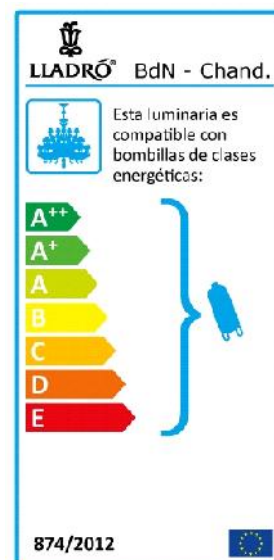



# Technical data sheet

**CE:** Ref 01023786 - UPC/EAN 737859237867  
**UK:** Ref 01023786 - UPC/EAN 737859237867  
**US:** Ref 01023787 - UPC/EAN 737859237867  
**JP:** Ref 01023788 - UPC/EAN 737859237867

**Description:**

**Belle de Nuit - Chandelier 56 lights - gold**  
**Belle de Nuit - Chandelier 56 luces - oro**

**Collection:**

**BELLE DE NUIT**

**Mounting:**

Chandelier

**Environment:**

Belle de Nuit is a special plant. During the night, its petals seem to reflect the moonlight, and take on the magical property of glowing in the dark. The flower opens in the evening which is why it is also known in English as the four o'clock flower. It has a multitude of colors and mottled flowers with countless nuances. When the plant matures, its colors change and a yellow flower becomes a deep pink while a white flower becomes violet.

**Installation and assembly:**

Follow instructions of the installation guide

**Electrical characteristics:**

**Max. Power:** 56 x 18W  
**Tension:** CE-UK: 220/240VAC US-JP: 100/125VAC  
**Frequency:** 50/60Hz  
 Dimmer not included / LED bulb non dimmable

**Recommended Bulb**

Bulb not included	<b>Bulb reference</b>
<b>CE:</b> 56 x G9 Led 3W 220V (190Lm)	01089407
<b>US:</b> 56 x G9 Led 3W 110V (190Lm)	

**Certificates:**

CE  
UL

**Physical characteristics:**

1 Box / 265,05 x 100 x 100 cm / 2,65 m3  
 1 Box / 104 1/4 x 39 1/4 x 39 1/4 inches / 160604 in3  
 Gross weight 200 Kg. / Net weight 48,7 Kg.



**Sketch**

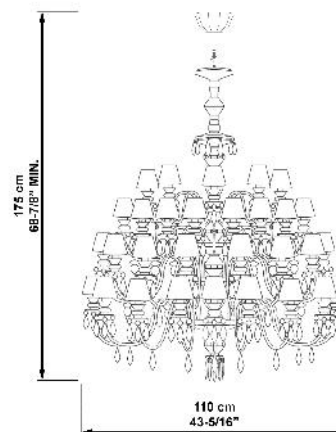

# Technical data sheet

**CE:** Ref 01023789 - UPC/EAN 737859237898  
**UK:** Ref 01023789 - UPC/EAN 737859237898  
**US:** Ref 01023790 - UPC/EAN 737859237898  
**JP:** Ref 01023791 - UPC/EAN 737859237898

**Description:**

**Belle de Nuit - Chandelier 56 lights. Absolute black**  
**Belle de Nuit - Chandelier 56 luces. Negro absoluto**

**Collection:**

**BELLE DE NUIT**

**Mounting:**

Chandelier

**Environment:**

Chandelier entirely made in porcelain. Made in different finishes to be able to match all decorative ambiences. Not very heavy to make more easy its installation. Bespoke measures under request.

**Installation and assembly:**

Follow instructions of the installation guide

**Electrical characteristics:**

**Max. Power:** 56 x 18W  
**Tension:** CE-UK: 220/240VAC US-JP: 100/125VAC  
**Frequency:** 50/60Hz  
 Dimmer not included / LED bulb non dimmable

**Recommended Bulb**

Bulb not included	<b>Bulb reference</b>
<b>CE:</b> 56 x G9 Led 3W 220V (190Lm)	01089407
<b>US:</b> 56 x G9 Led 3W 110V (190Lm)	

**Certificates:**

CE  
UL

**Physical characteristics:**

1 Box / 265,05 x 100 x 100 cm / 2,65 m3  
 1 Box / 104 1/4 x 39 1/4 x 39 1/4 inches / 160604 in3  
 Gross weight 200 Kg. / Net weight 48,7 Kg.



**LLADRÓ** BdN - Chand.

Esta luminaria es compatible con bombillas de clases energéticas:

A++  
A+  
A  
B  
C  
D  
E

874/2012 

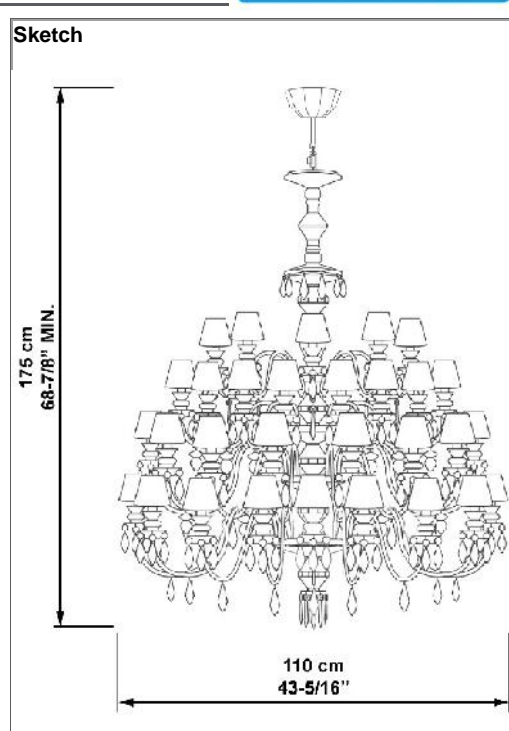

# Technical data sheet

**CE:** Ref 01023795 - UPC/EAN 737859237959  
**UK:** Ref 01023795 - UPC/EAN 737859237959  
**US:** Ref 01023796 - UPC/EAN 737859237959  
**JP:** Ref 01023797 - UPC/EAN 737859237959

**Description:**

**Belle de Nuit - Chandelier 12 lights. Silver**  
**Belle de Nuit - Chandelier 12 luces. Plata**

**Collection:**

**BELLE DE NUIT**

**Mounting:**

Chandelier

**Environment:**

Chandelier entirely made of porcelain. Made in different finishes to match all decorative ambiences. Not very heavy to simplify its installation. Bespoke measures available under request.

**Installation and assembly:**

Follow instructions of the installation guide

**Electrical characteristics:**

**Max. Power:** 12 x 18W  
**Tension:** CE-UK: 220/240VAC US-JP: 100/125VAC  
**Frequency:** 50/60Hz  
 Dimmer not included / LED bulb non dimmable

**Recommended Bulb**

Bulb not included	<b>Bulb reference</b>
<b>CE:</b> 12 x G9 Led 3W 220V (190Lm)	01089407
<b>US:</b> 12 x G9 Led 3W 110V (190Lm)	

**Certificates:**

CE, SASO  
UL

**Physical characteristics:**

1 Box / 111 x 82 x 82 cm / 0,746 m3  
 1 Box / 43 3/4 x 32 1/4 x 32 1/4 inches / 45503 in3  
 Gross weight 29,6 Kg. / Net weight 8,3 Kg.

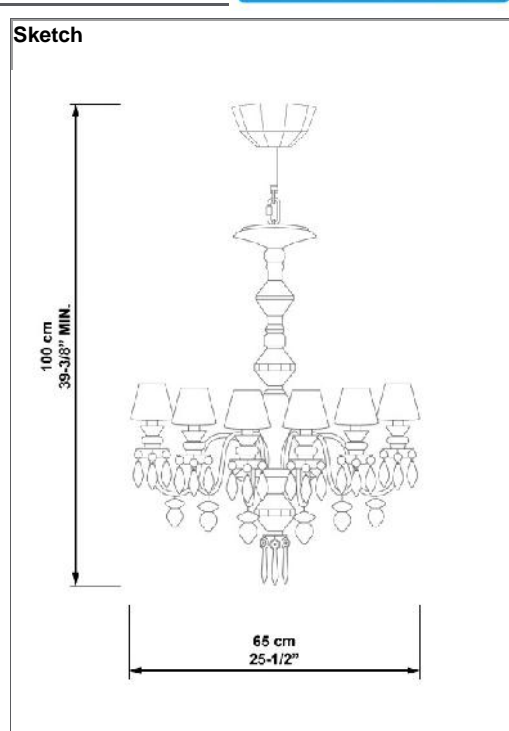
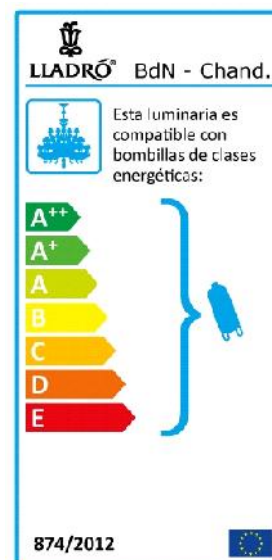

# Technical data sheet

**CE:** Ref 01023913 - UPC/EAN 737859239137  
**UK:** Ref 01023913 - UPC/EAN 737859239137  
**US:** Ref 01023914 - UPC/EAN 737859239137  
**JP:** Ref 01023915 - UPC/EAN 737859239137

**Description:**

**Belle de Nuit - Chandelier 24 lights - silver**  
**Belle de Nuit - Chandelier 24 luces - plata**

**Collection:**

**BELLE DE NUIT**

**Mounting:**

Chandelier

**Environment:**

Chandelier entirely made of porcelain. Made in different finishes to match all decorative ambiences. Not very heavy to simplify its installation. Bespoke measures available under request.

**Installation and assembly:**

Follow instructions of the installation guide

**Electrical characteristics:**

**Max. Power:** 24 x 18W  
**Tension:** CE-UK: 220/240VAC US-JP: 100/125VAC  
**Frequency:** 50/60Hz  
 Dimmer not included / LED bulb non dimmable

**Recommended Bulb**

Bulb not included	<b>Bulb reference</b>
<b>CE:</b> 24 x G9 Led 3W 220V (190Lm)	01089407
<b>US:</b> 24 x G9 Led 3W 110V (190Lm)	

**Certificates:**

CE, SASO  
UL

**Physical characteristics:**

1 Box / 135 x 105 x 105 cm / 1,488 m3  
 1 Box / 53 1/4 x 41 1/4 x 41 1/4 inches / 90608 in3  
 Gross weight 44,1 Kg. / Net weight 21,16 Kg.



**LLADRÓ** BdN - Chand.

Esta luminaria es compatible con bombillas de clases energéticas:

A++  
A+  
A  
B  
C  
D  
E

874/2012 



**Sketch**

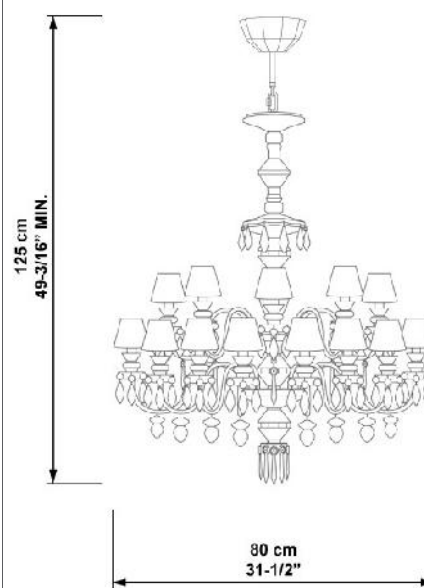

# Technical data sheet

**CE:** Ref 01023916 - UPC/EAN 737859239168  
**UK:** Ref 01023916 - UPC/EAN 737859239168  
**US:** Ref 01023917 - UPC/EAN 737859239168  
**JP:** Ref 01023918 - UPC/EAN 737859239168

**Description:**

**Belle de Nuit - Chandelier 40 lights - silver**  
**Belle de Nuit - Chandelier 40 luces - Plata**

**Collection:**

**BELLE DE NUIT**

**Mounting:**

Chandelier

**Environment:**

Chandelier entirely made of porcelain. Made in different finishes to match all decorative ambiances. Not very heavy to simplify its installation. Bespoke measures available under request.

**Installation and assembly:**

Follow instructions of the installation guide

**Electrical characteristics:**

**Max. Power:** 40 x 18W  
**Tension:** CE-UK: 220/240VAC US-JP: 100/125VAC  
**Frequency:** 50/60Hz  
 Dimmer not included / LED bulb non dimmable

**Recommended Bulb**

Bulb not included	<b>Bulb reference</b>
<b>CE:</b> 40 x G9 Led 3W 220V (190Lm)	01089407
<b>US:</b> 40 x G9 Led 3W 110V (190Lm)	

**Certificates:**

CE, SASO  
UL

**Physical characteristics:**

1 Box / 140 x 119 x 119 cm / 1,983 m3  
 1 Box / 55 x 46 3/4 x 46 3/4 inches / 120206 in3  
 Gross weight 129,6 kg. / Net weight 27,36 kg.



**LLADRÓ** BdN - Chand.

Esta luminaria es compatible con bombillas de clases energéticas:

A++  
A+  
A  
B  
C  
D  
E

874/2012



**Sketch**

